



The addition of two-spirit levels is a matter of course, thanks to which your measurement in both planes will be very accurate and fun.

Cloned antenna series are available through [AU Technology](#), which guarantees constant parameters.

Manufactured with RF SPIN's [SPM Technology](#) to achieve the best mechanical and radio parameters.



See the equivalent outdoor antenna [QRH18R](#)

Features and Specifications



Technical Performance

- Wide bandwidth
- Low return loss
- Individual calibration



Design and Surface Treatment

- Corrosion-resistant coating
- Includes standard mount
- Very precise spirit level for both polarizations



Manufacturing Technology

- Manufactured using a high grade aluminum alloy
- Extremely durable
- High quality SMA type coaxial connector



Product Packaging Includes

- Adapter with ¼ inch inner thread, supplied with antenna
- Linear polarized double ridged broadband horn antenna

Product Parameters

PRODUCT IDENTIFICATION

Product Name	QRH18
Product Category	Quad Ridged Horn Antenna

ELECTRICAL SPECIFICATIONS

Frequency Range	1 GHz – 18 GHz
VSWR (max.)	2.5
VSWR (avg.)	1.45
Impedance	50 Ohm
Connector	SMA (female)
Power (CW / Peak)	100 W / 170 W
Antenna Factor	24.3 – 40 dB/m
Port Isolation	-30 dB
Polarization	Dual Linear, Circular (with hybrid)

PHYSICAL SPECIFICATIONS

Width	230.6 mm (9.079 in)
Height	229.1 mm (9.020 in)
Depth	230.6 mm (9.079 in)
Weight	0.65 kg (1.433 lb)

OPERATING CONDITIONS

Rated Temperature Range	0°C – +50°C
Storage Temperature Range	-20°C – +70°C

MOUNTING FLANGE

Mounting	Adapter with ¼ inch inner thread, supplied with antenna
----------	--

Mechanical Drawings

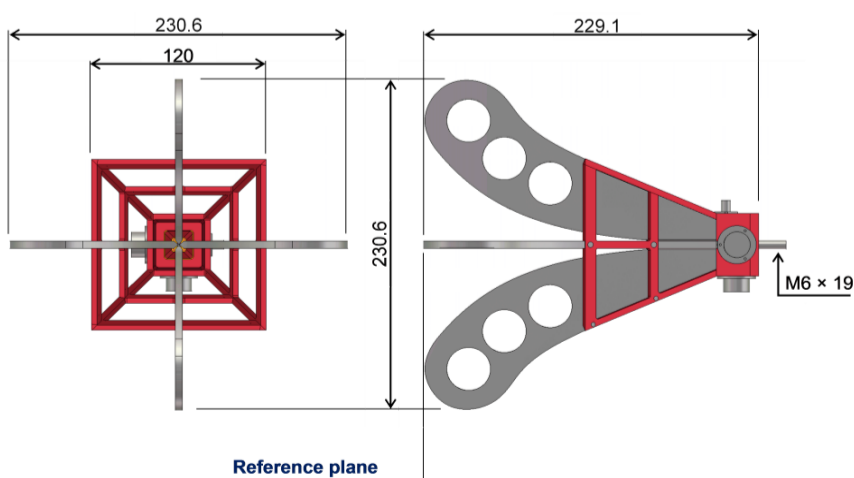

Mounting flange

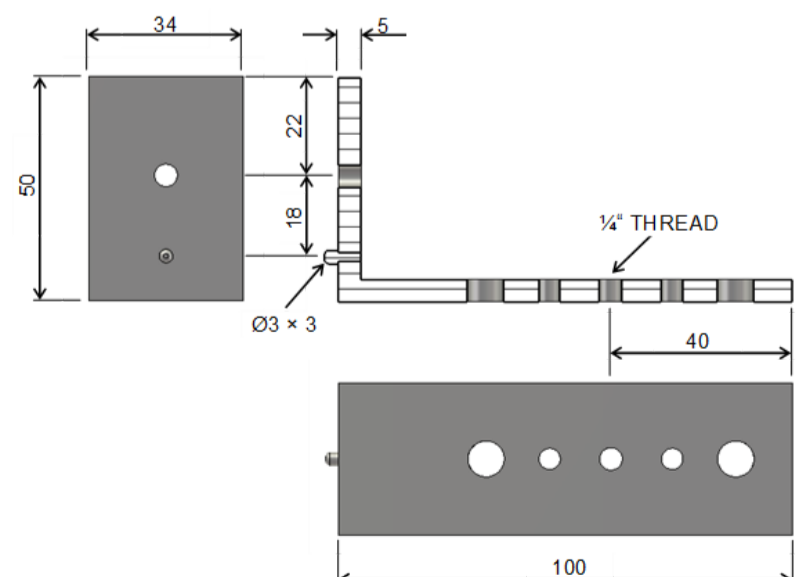

Parameters and Performance

Typical parameters

VSWR

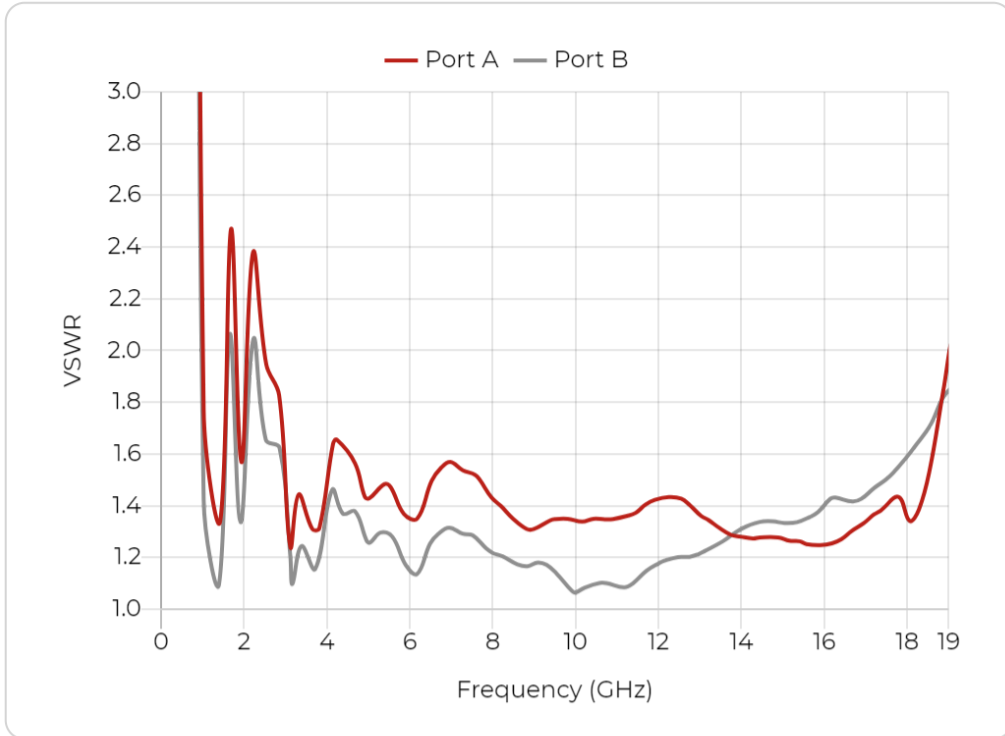

Gain

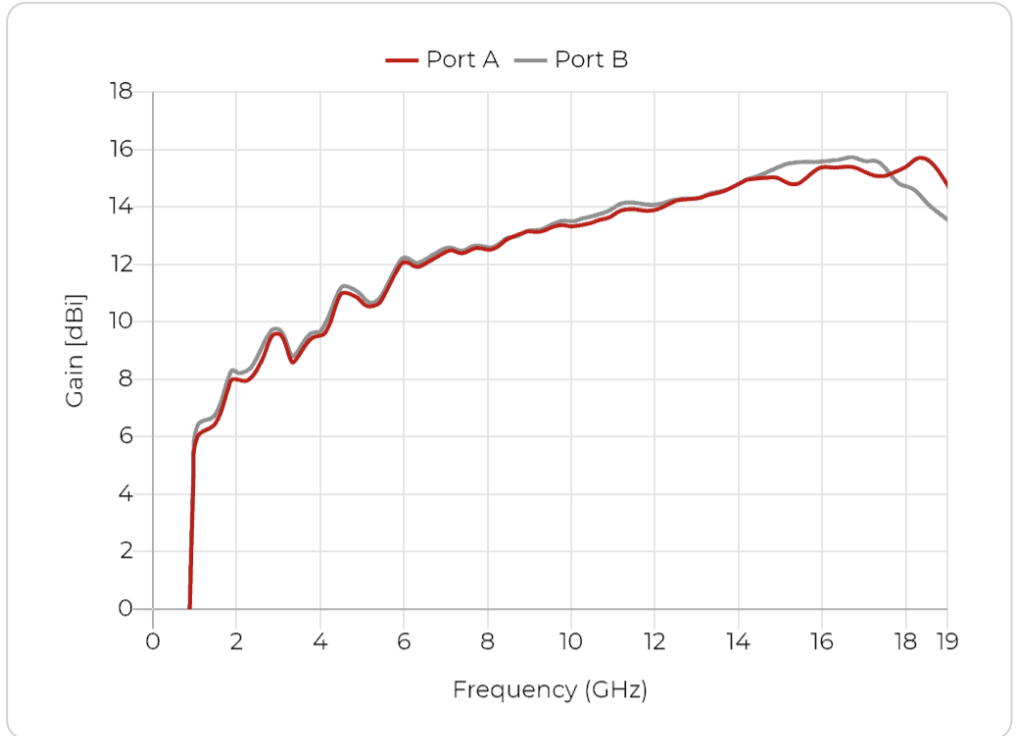

Antenna Factor

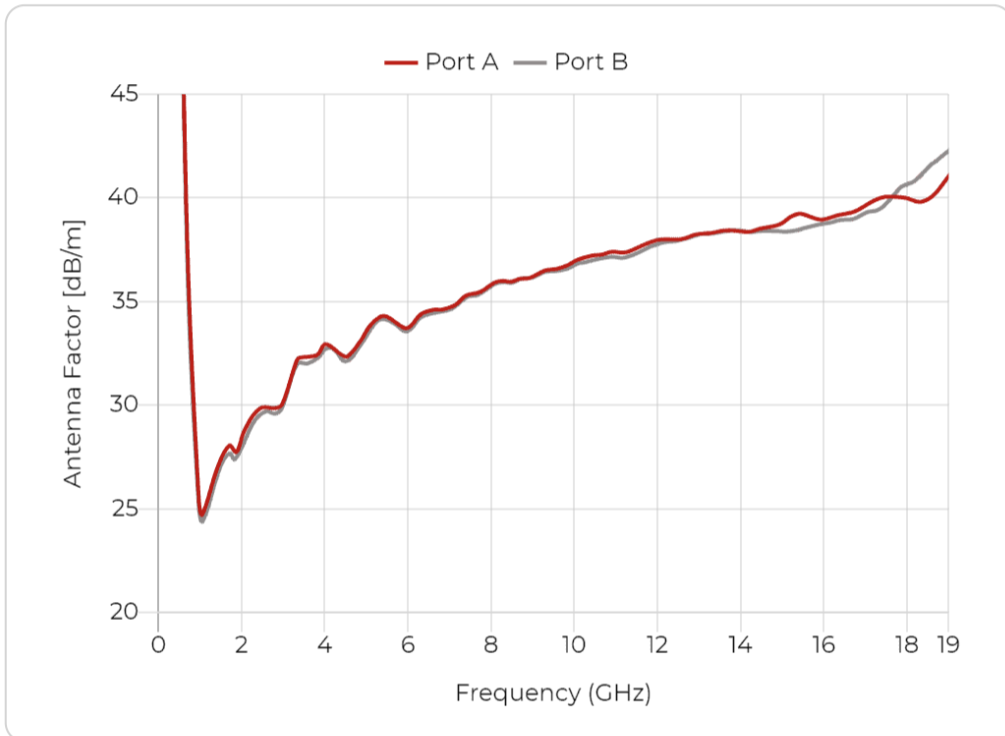

Port Isolation

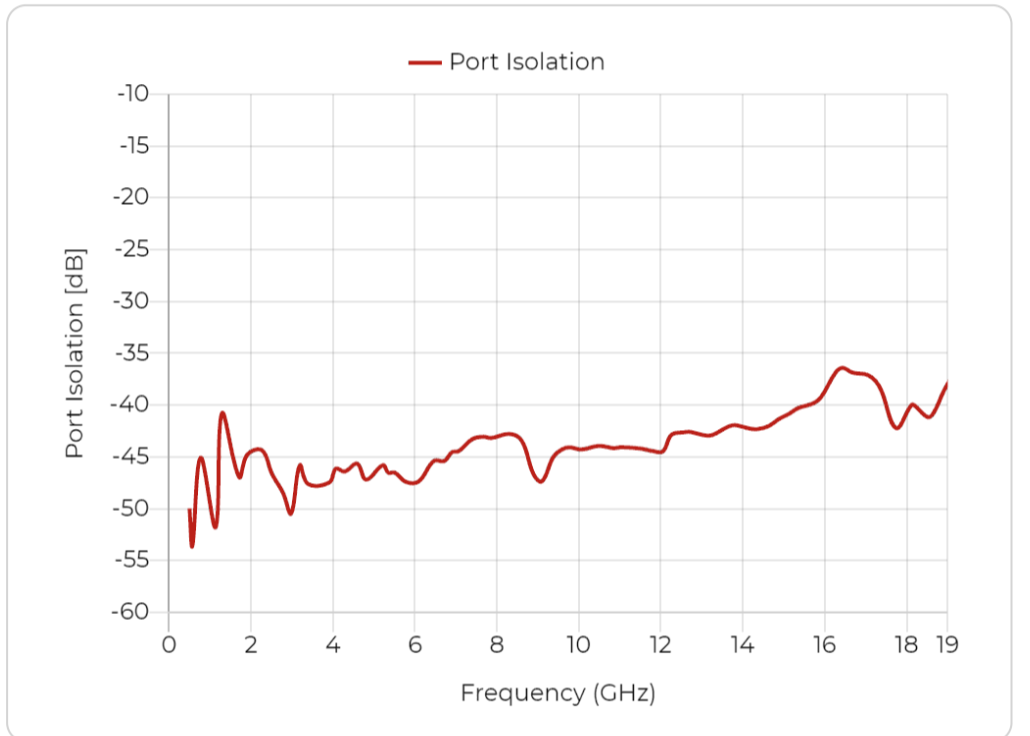

Cross Polarization

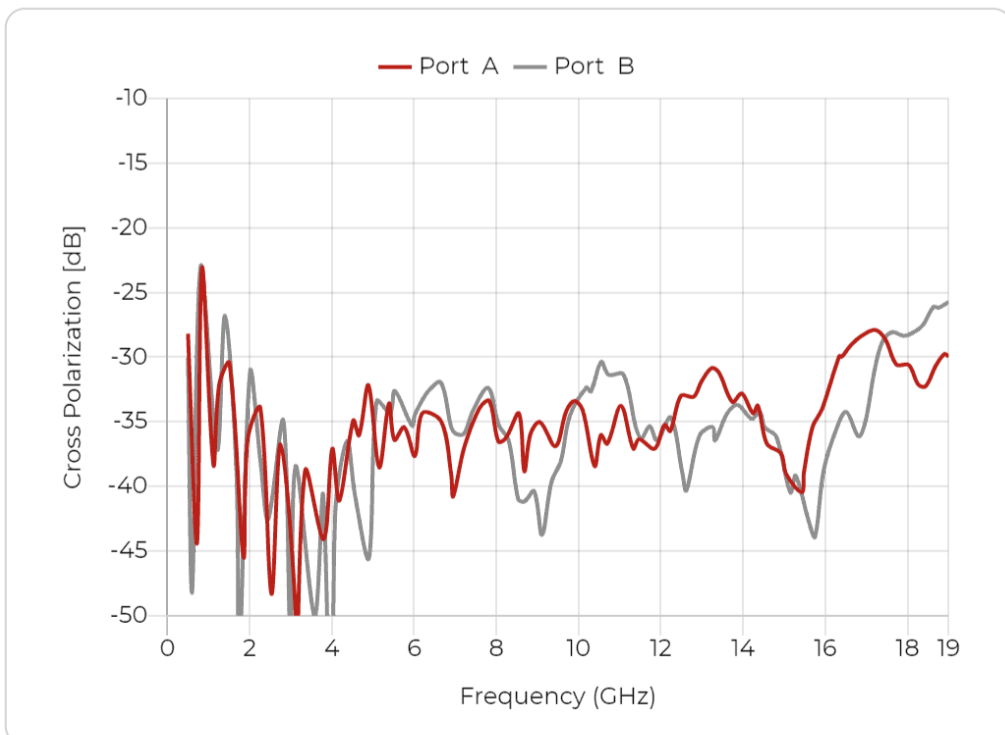

Beamwidth

Port A, E plane

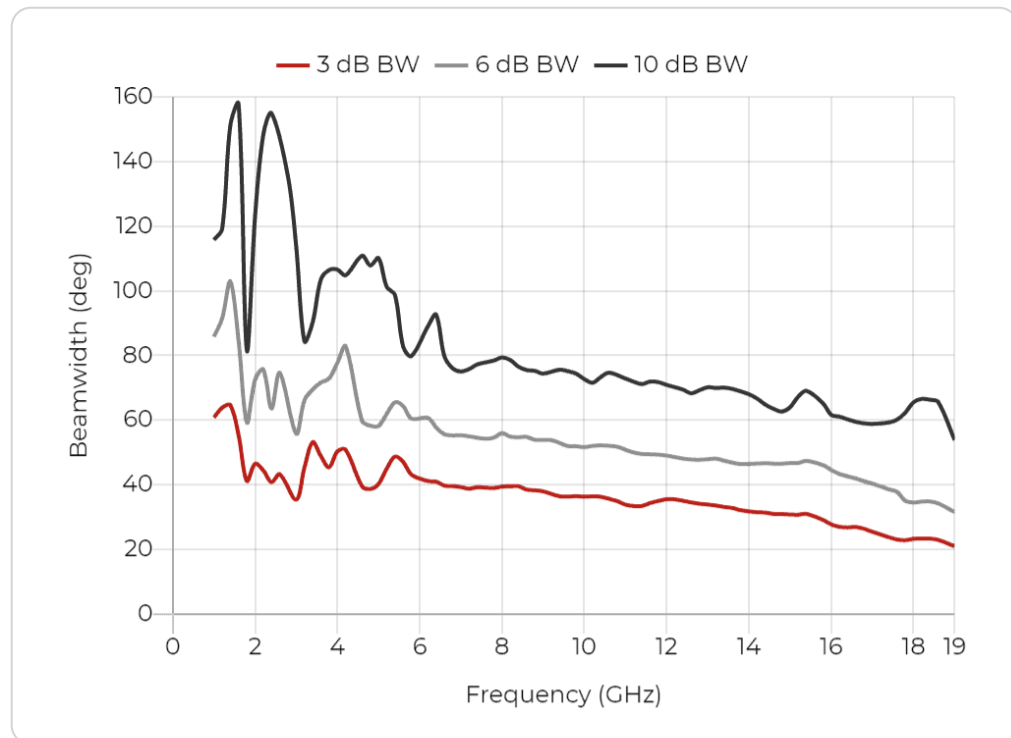

Port A, H plane

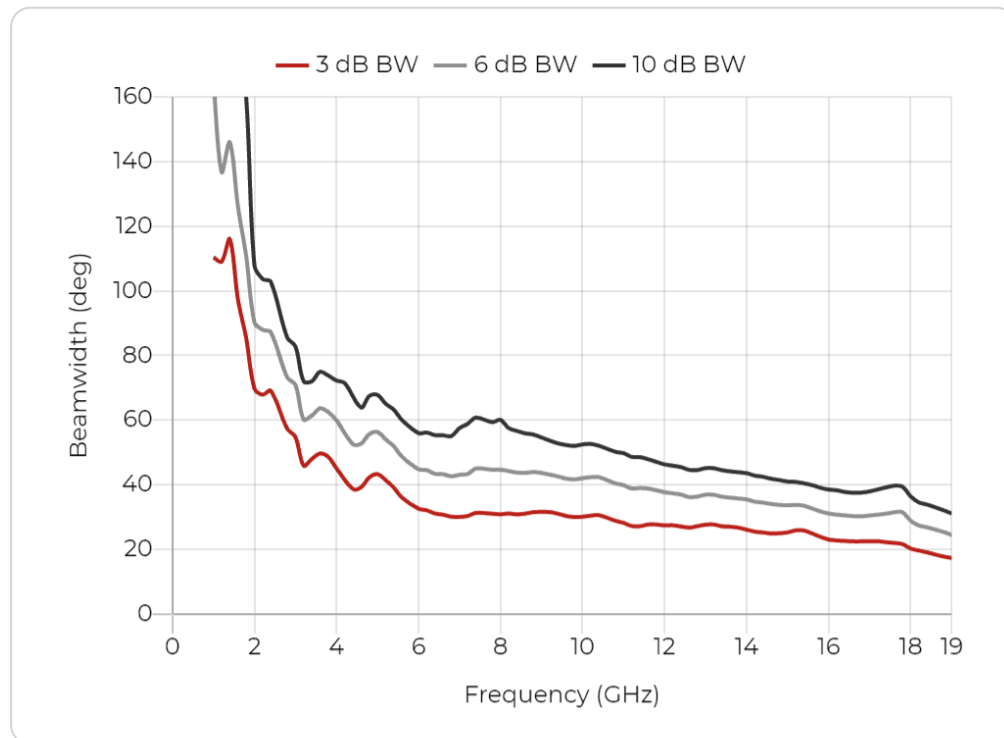

Port B, E plane

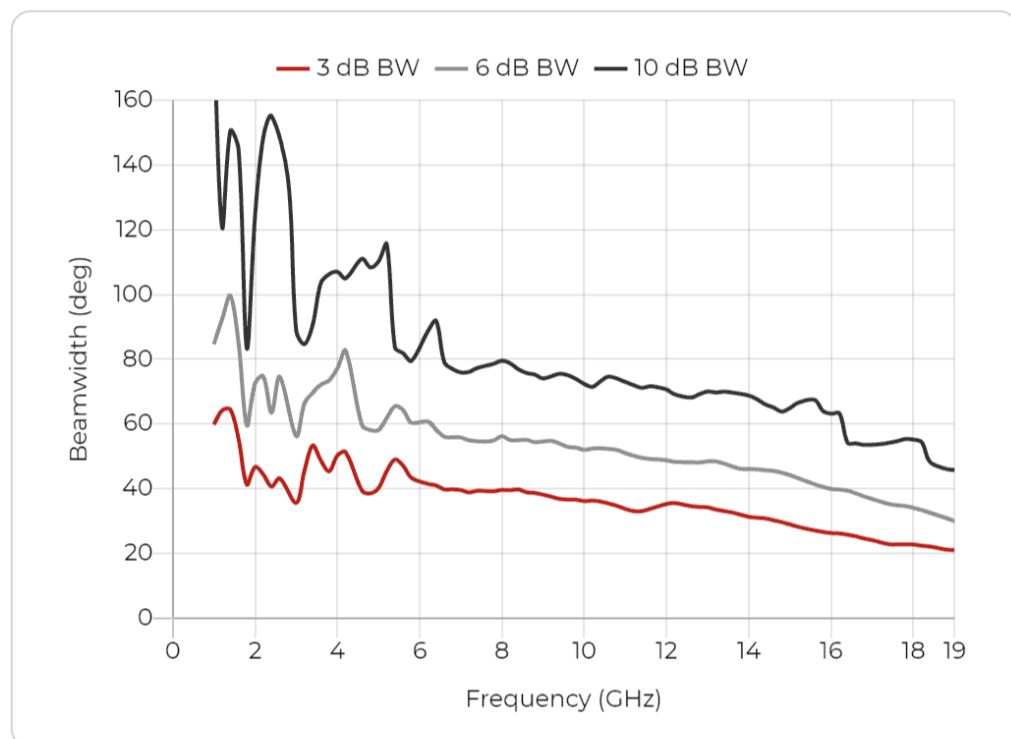

Port B, H plane

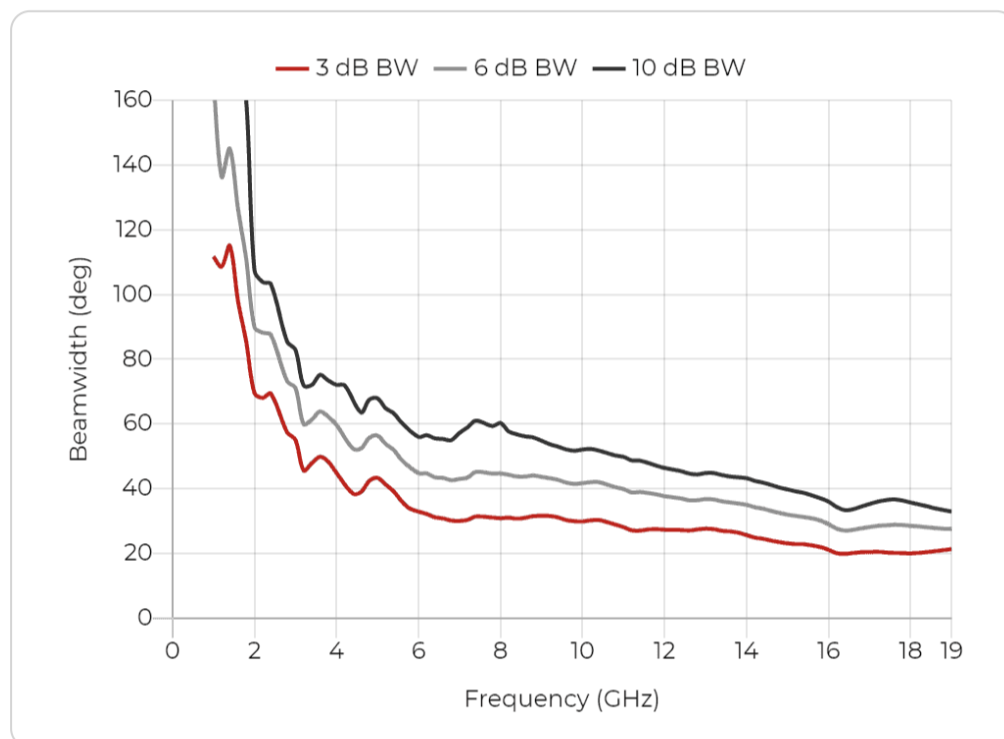

Radiation Patterns - Port A

Port A, 1 GHz

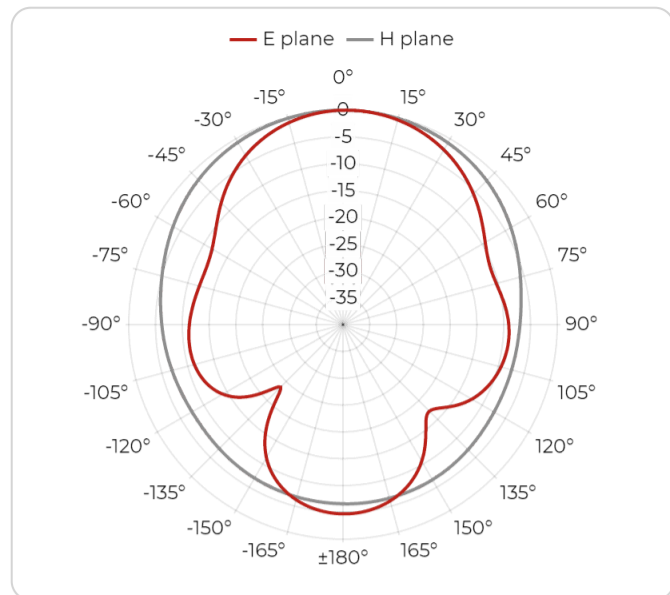

Port A, 2 GHz

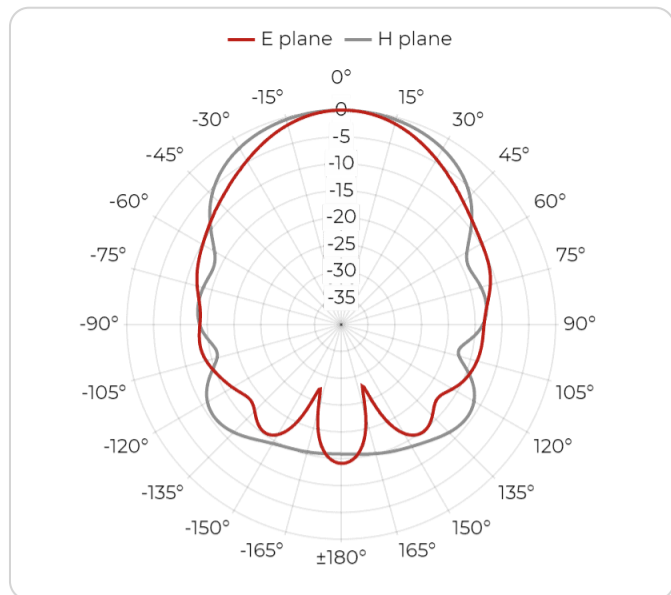

Port A, 3 GHz

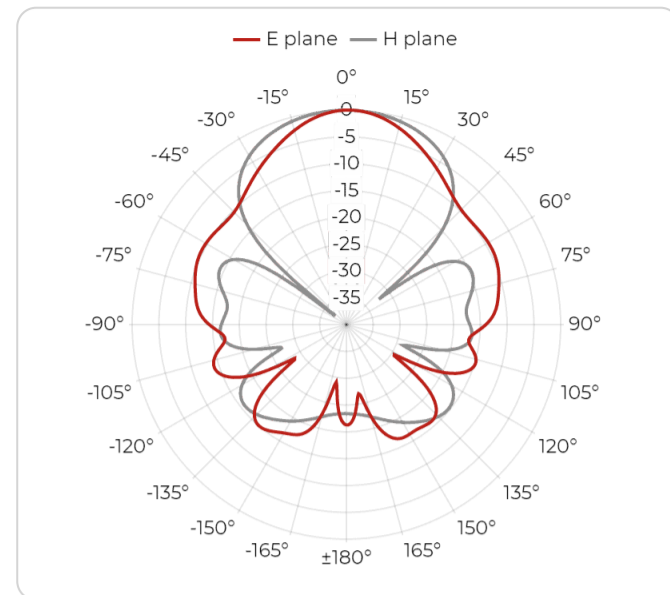

Port A, 4 GHz

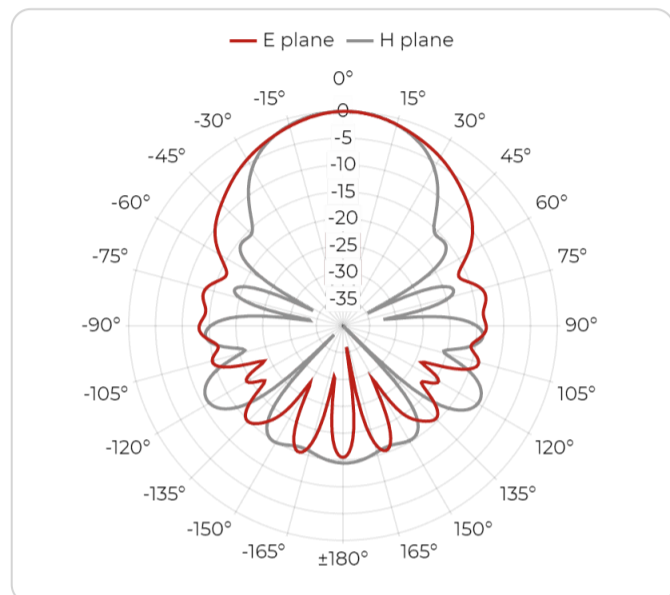

Port A, 5 GHz

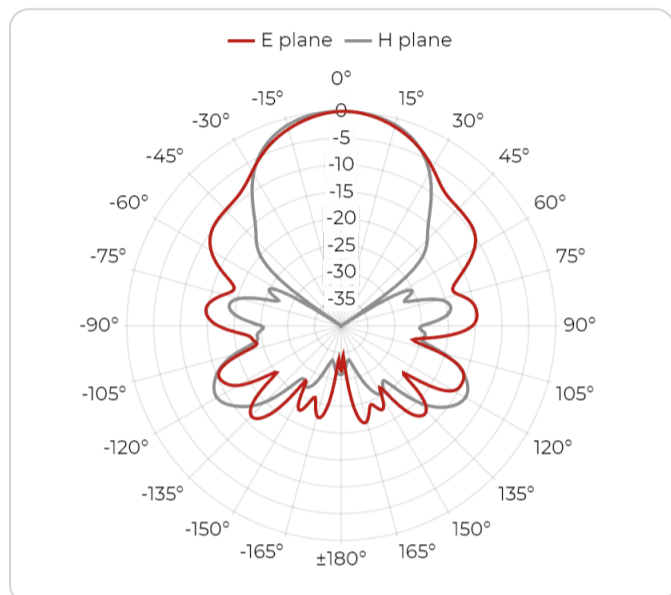

Port A, 6 GHz

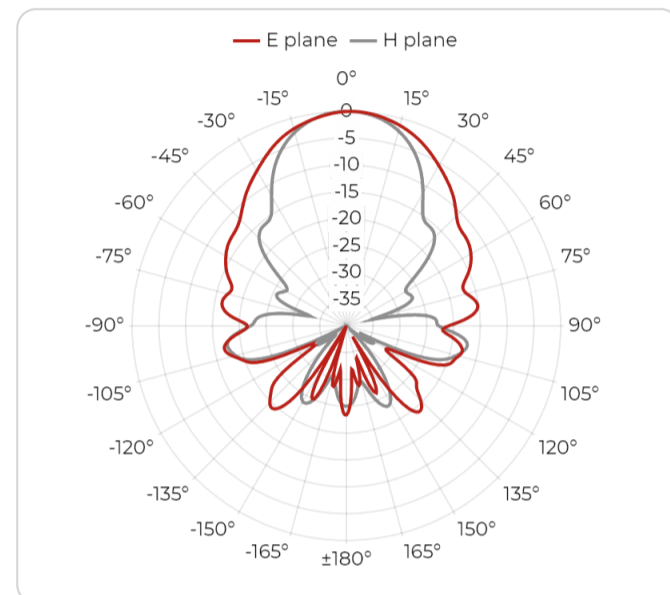

Port A, 8 GHz

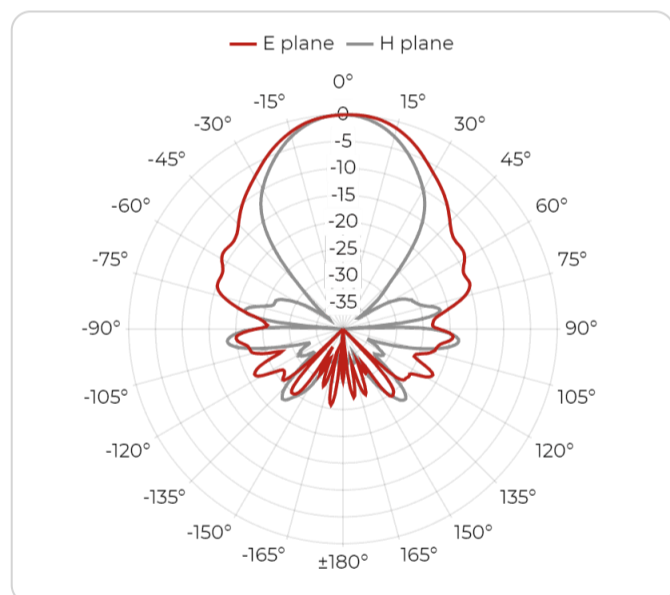

Port A, 10 GHz

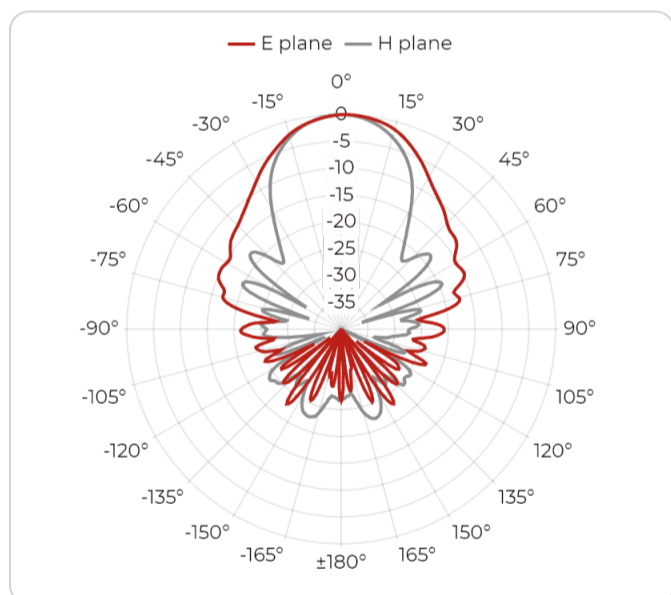

Port A, 12 GHz

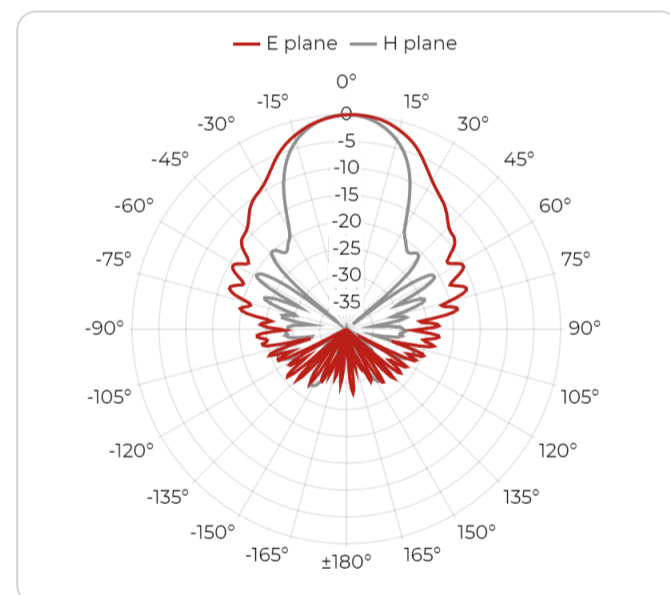

Port A, 14 GHz

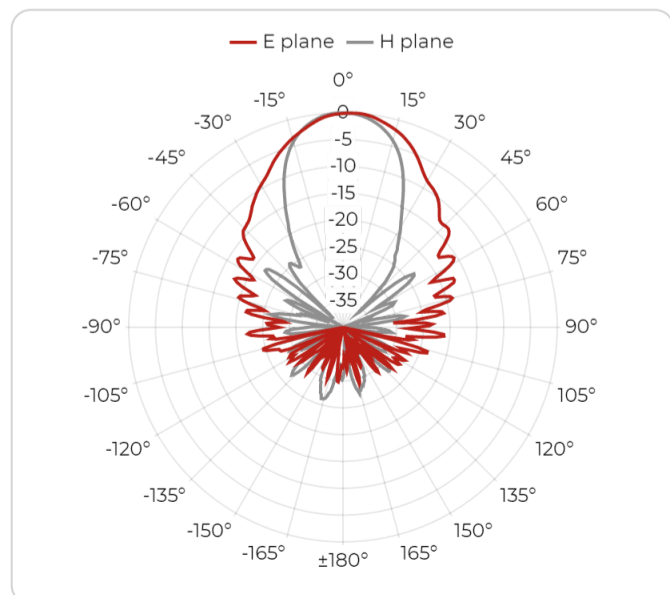

Port A, 16 GHz

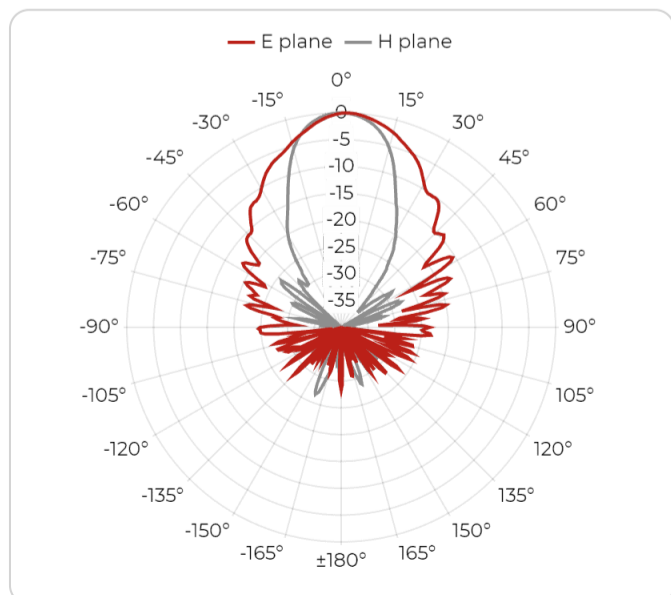

Port A, 18 GHz

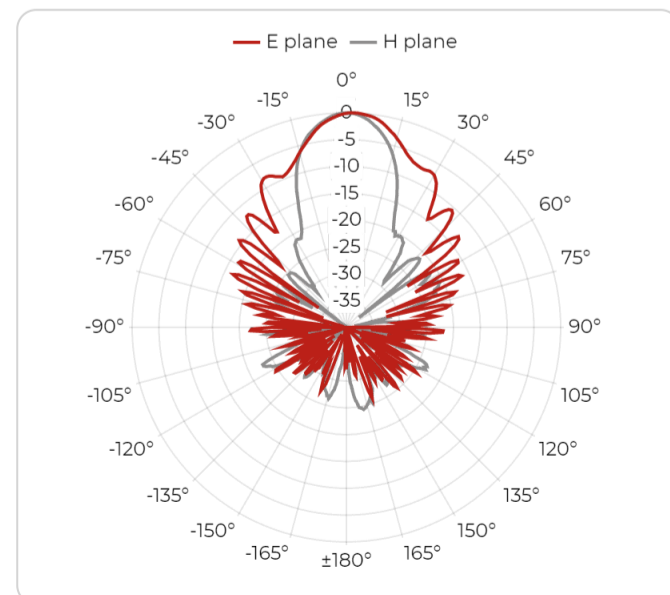

Radiation Patterns - Port B

Port B, 1 GHz

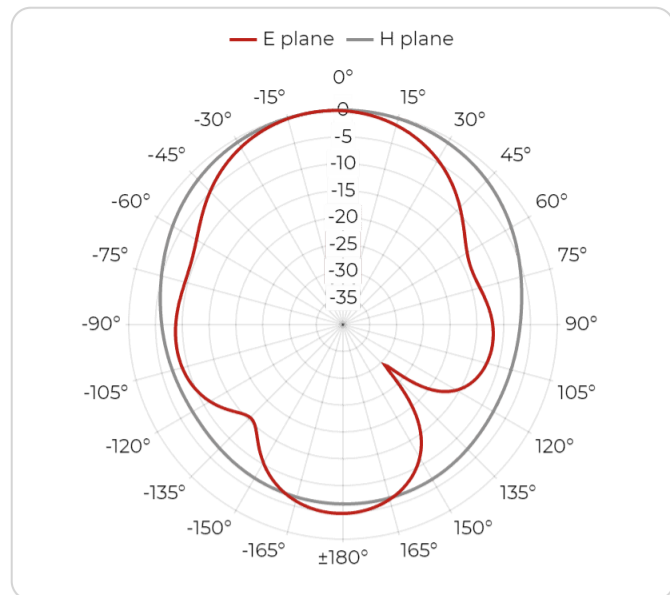

Port B, 2 GHz

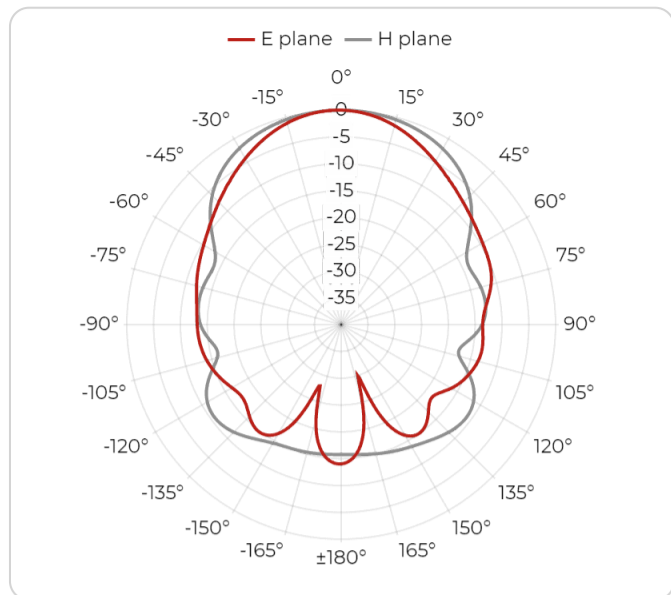

Port B, 3 GHz

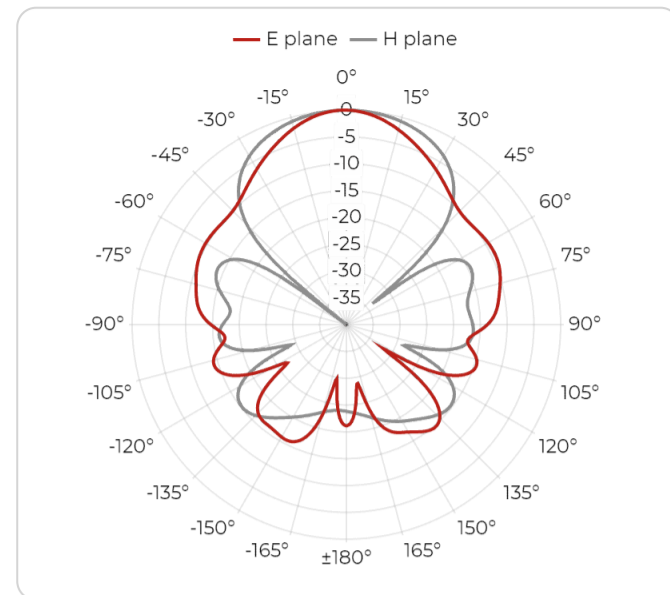

Port B, 4 GHz

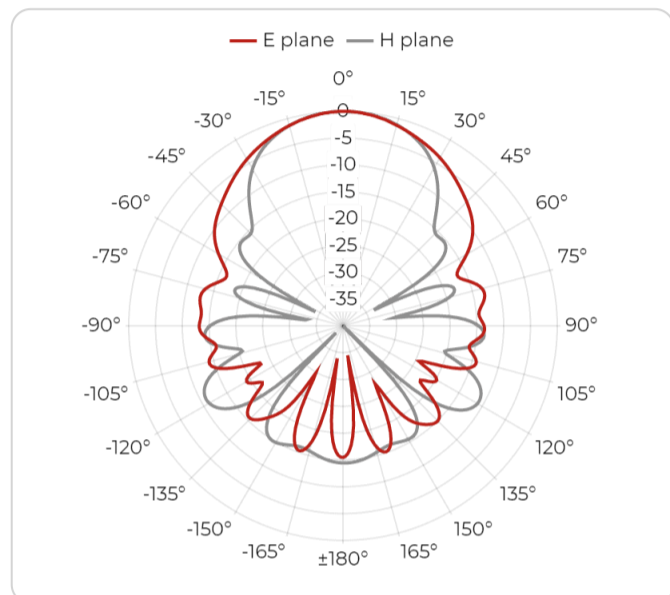

Port B, 5 GHz

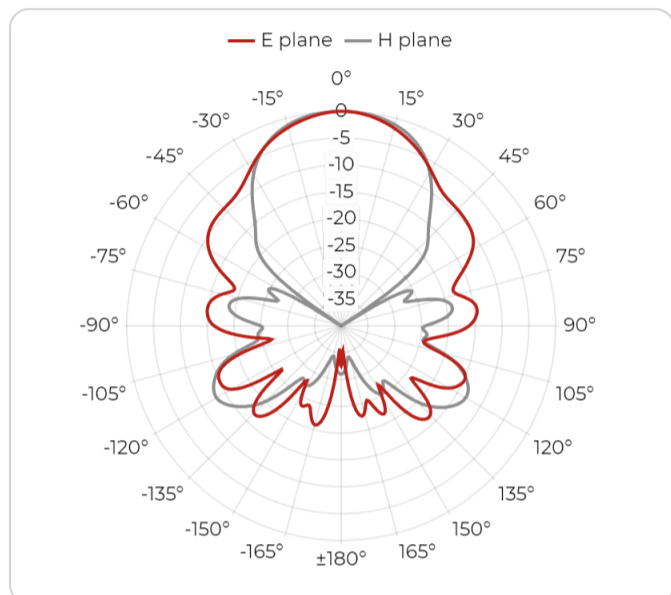

Port B, 6 GHz

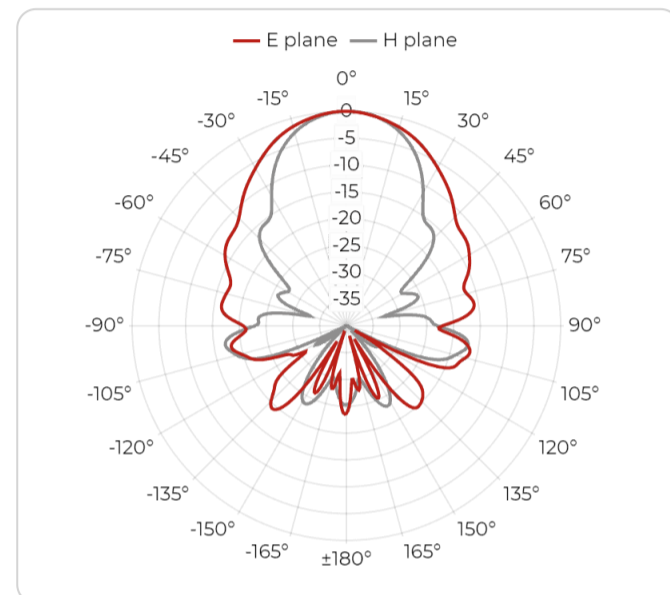

Port B, 8 GHz

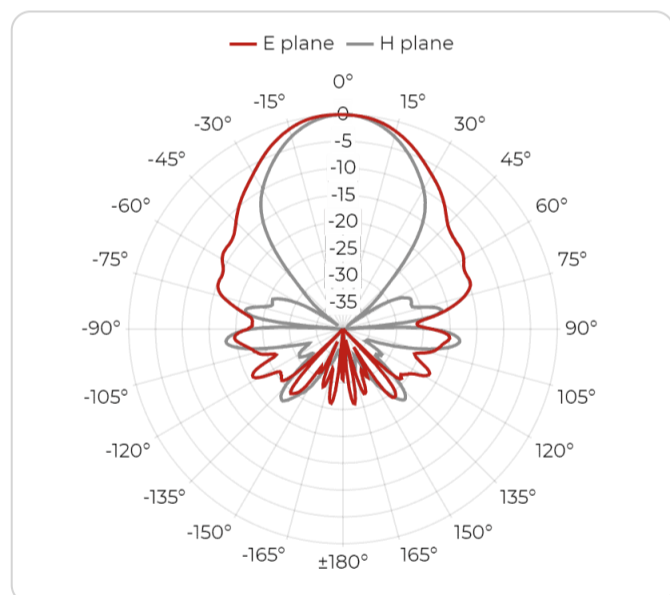

Port B, 10 GHz

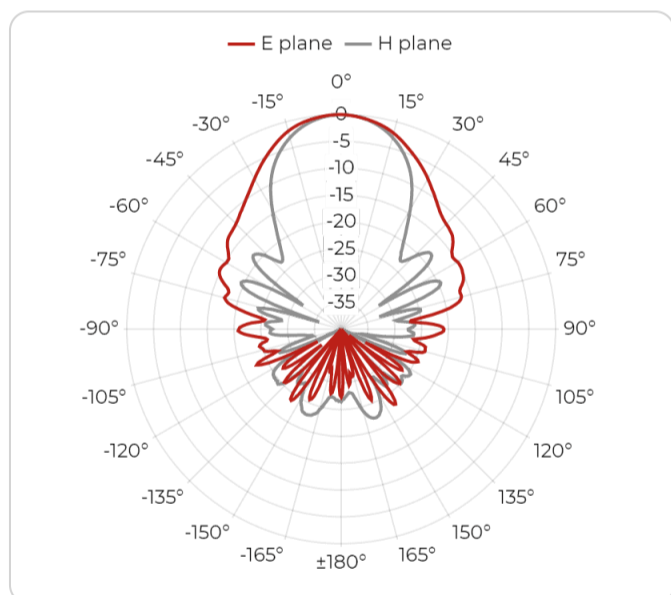

Port B, 12 GHz

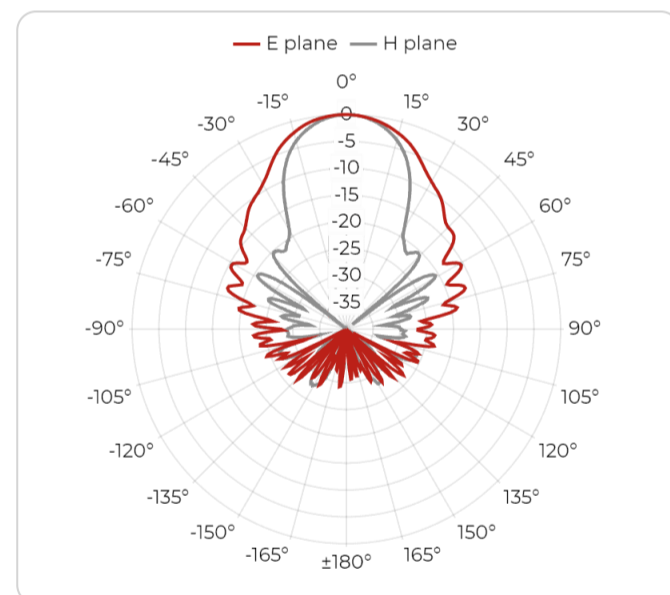

Port B, 14 GHz

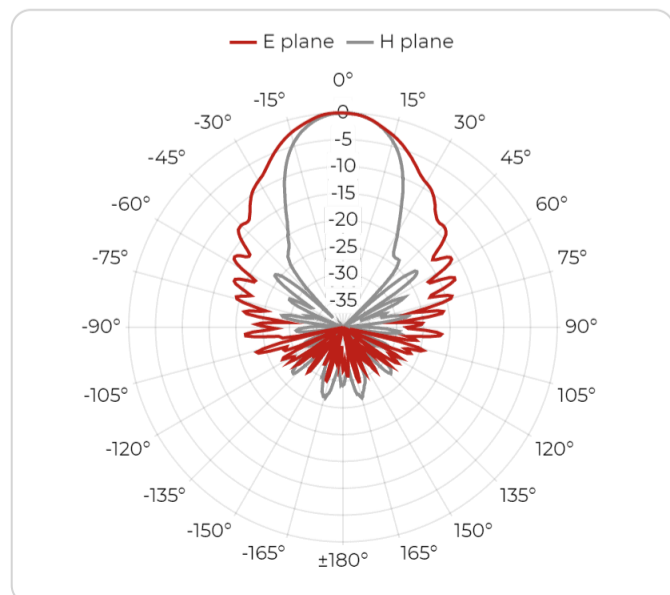

Port B, 16 GHz

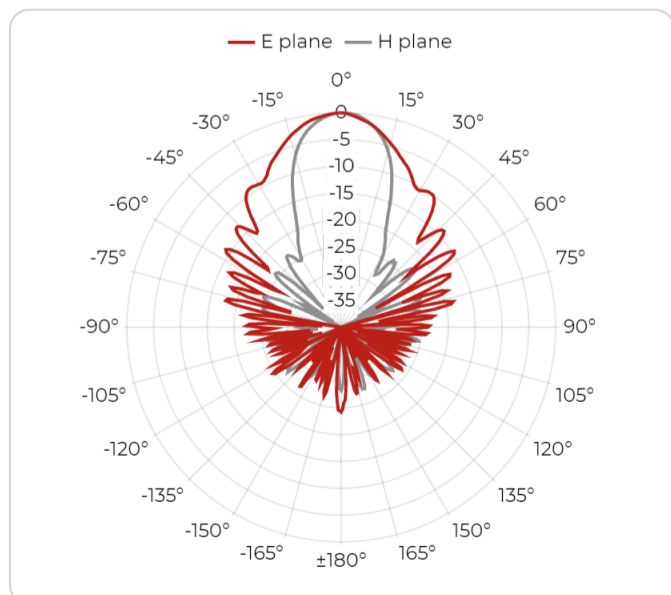

Port B, 18 GHz

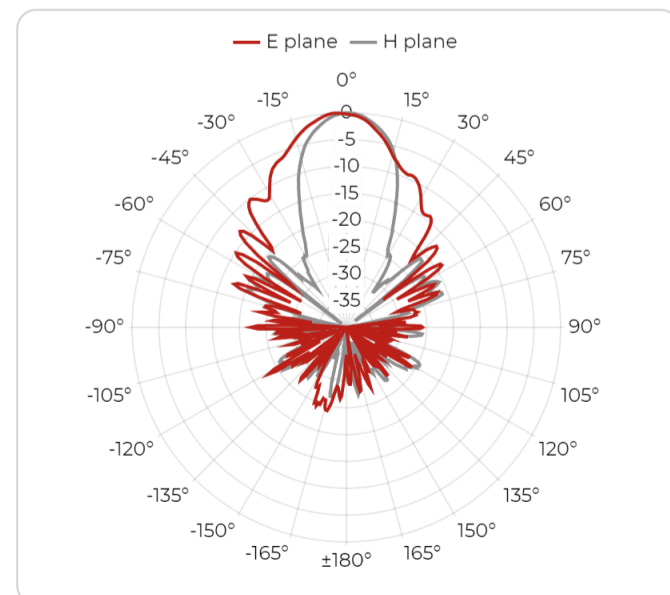

Packaging and Accessories

What's in a box

- QRH18 Antenna
- Antenna specific mount adapter with ¼ inch inner thread
- Factory calibration certificate
- Full calibration report of each antenna
- QR code accessing online portal
- Calibration test dataset (available online)

Accessories

- Standard mounting flange

Custom services

- Custom mounting solutions
- Custom calibration data

Manufacturer Information

About Datasheet

Product information available also online at
<https://www.rfspin.com/product/grh18/>

Data and specifications subject to change without notice.

Datasheet revision 02-2024.

© RFspin 2024

📍 Address

RFspin s.r.o.
Na Beránce 57/2
160 00 Prague 6
Czech Republic

✉ E-mail

info@rfspin.com

📞 Phone

[+420 245 008 847](tel:+420245008847)