



The addition of a spirit level is a matter of course, thanks to which your measurement in both planes will be very accurate and fun. Two options of antenna connector N or SMA. This broadband antenna works from 0.8 GHz up to 18 GHz.

Cloned antenna series are available through [AU Technology](#), which guarantees constant parameters.

## Features and Specifications



### Technical Performance

- Wide bandwidth
- Low return loss
- Individual calibration



### Design and Surface Treatment

- Corrosion-resistant coating
- Includes standard mount
- Very precise spirit level



### Manufacturing Technology

- Extremely durable
- High quality SMA type coaxial connector
- High quality N type coaxial connector



### Product Packaging Includes

- Adapter with 1/4 inch inner thread, supplied with antenna
- Linear polarized double ridged broadband horn antenna

## Product Parameters

### PRODUCT IDENTIFICATION

Product Name	<b>DRH18-EX</b>
Product Category	<b>Double Ridged Horn Antenna</b>

### ELECTRICAL SPECIFICATIONS

Frequency Range	<b>800 MHz – 18 GHz</b>
VSWR (max.)	<b>2.5</b>
VSWR (avg.)	<b>1.3</b>
Impedance	<b>50 Ohm</b>
Connector	<b>N (female), SMA (female)</b>
Power (CW / Peak)	<b>100 W / 170 W</b>
Antenna Factor	<b>23 – 44 dB/m</b>
Polarization	<b>Linear</b>

### PHYSICAL SPECIFICATIONS

Width	<b>186 mm (7.323 in)</b>
Height	<b>232 mm (9.134 in)</b>
Depth	<b>216 mm (8.504 in)</b>
Weight	<b>0.87 kg (1.918 lb)</b>

### OPERATING CONDITIONS

Rated Temperature Range	<b>0°C – +50°C</b>
Storage Temperature Range	<b>-20°C – +70°C</b>

### MOUNTING FLANGE

Mounting	<b>Adapter with 1/4 inch inner thread, supplied with antenna</b>
----------	--

## Mechanical Drawings

Antenna

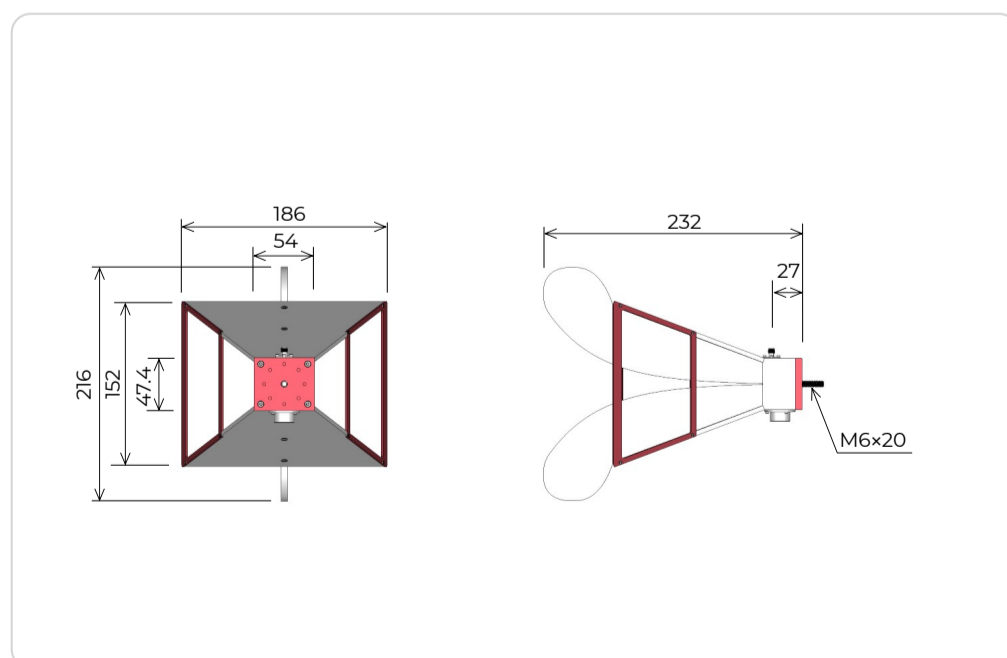

Mounting flange

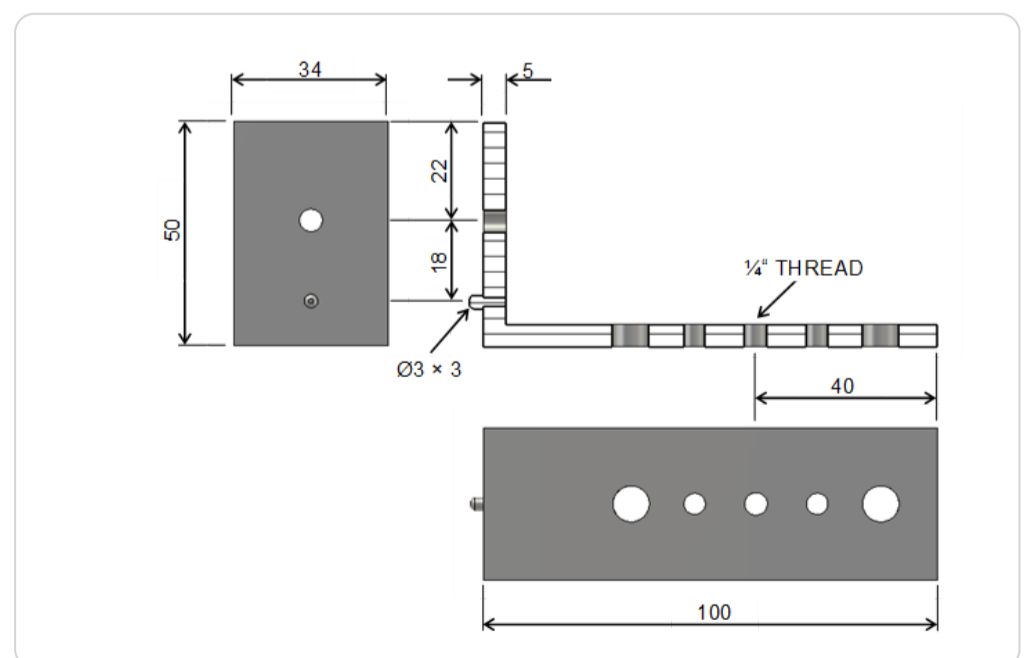

# Parameters and Performance

## Typical parameters

VSWR

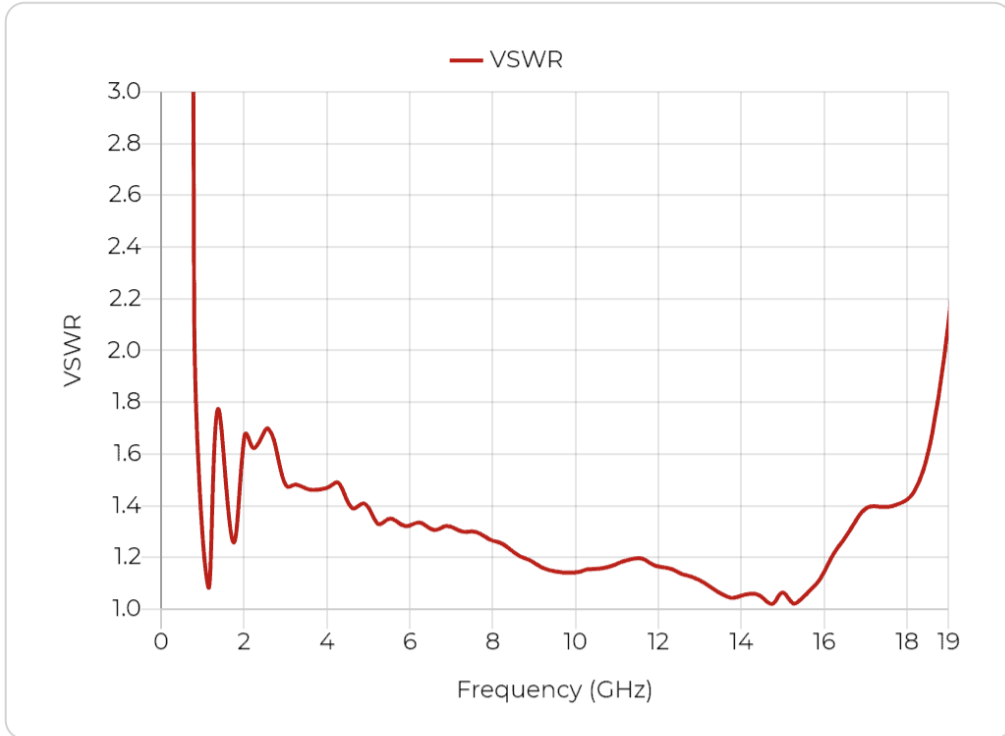

Gain

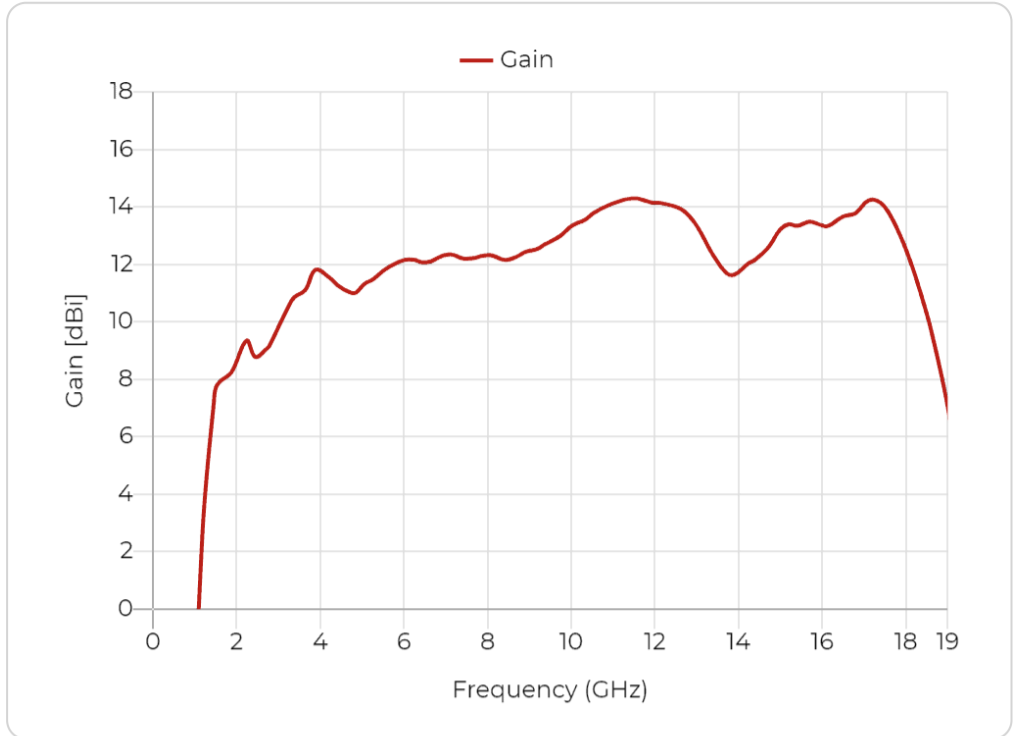

Antenna Factor

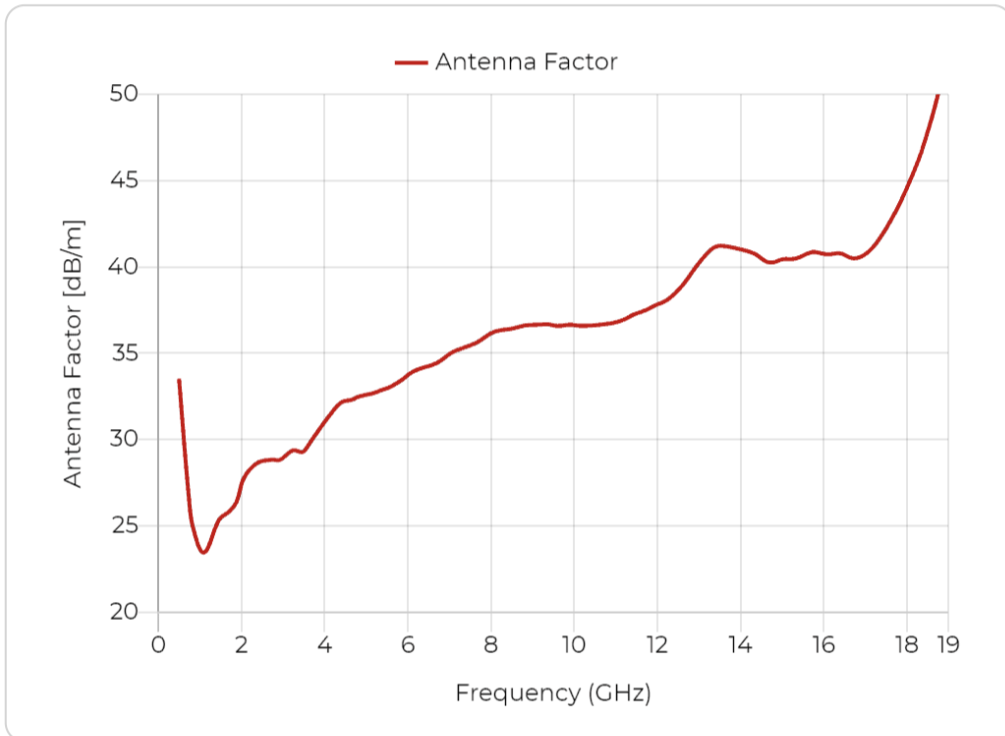

Cross Polarization

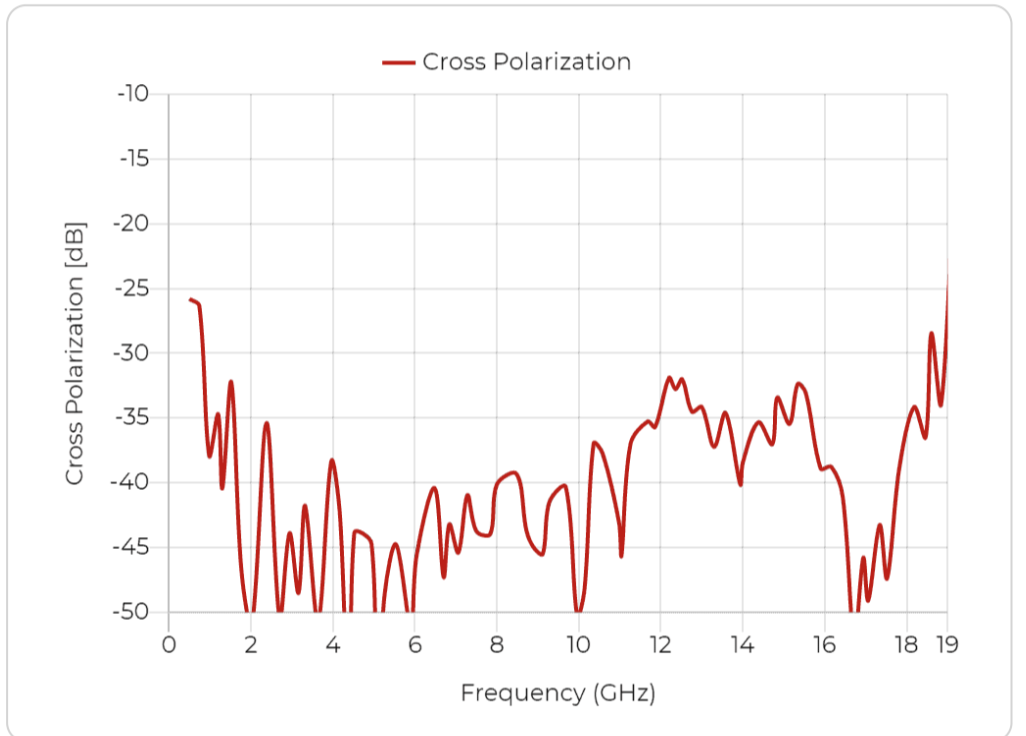

## Beamwidth

Port A, E plane

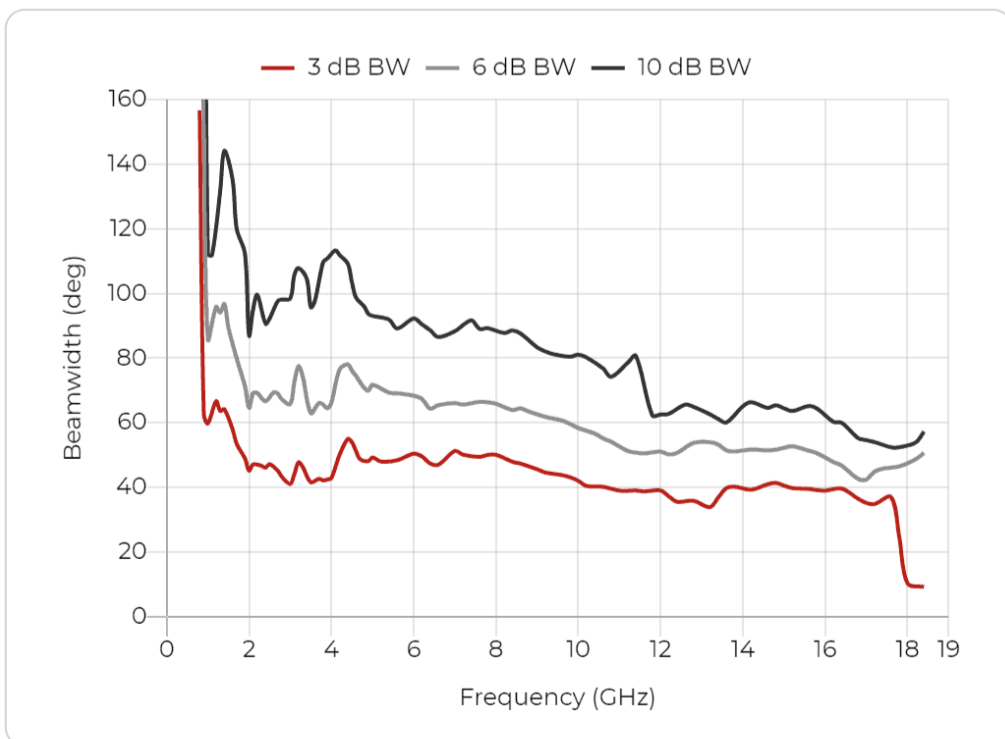

Port A, H plane

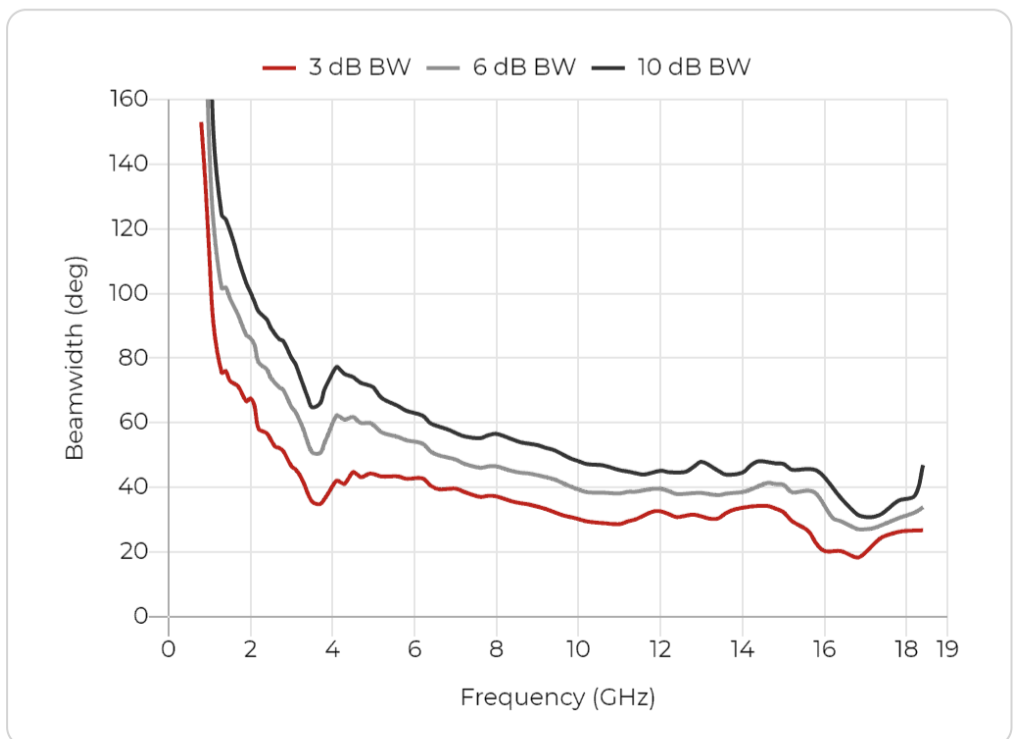

# Radiation Patterns

0.8 GHz

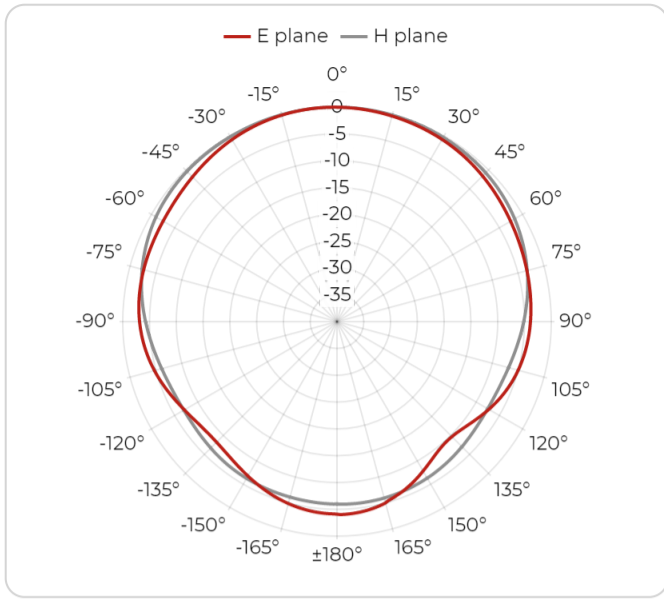

1 GHz

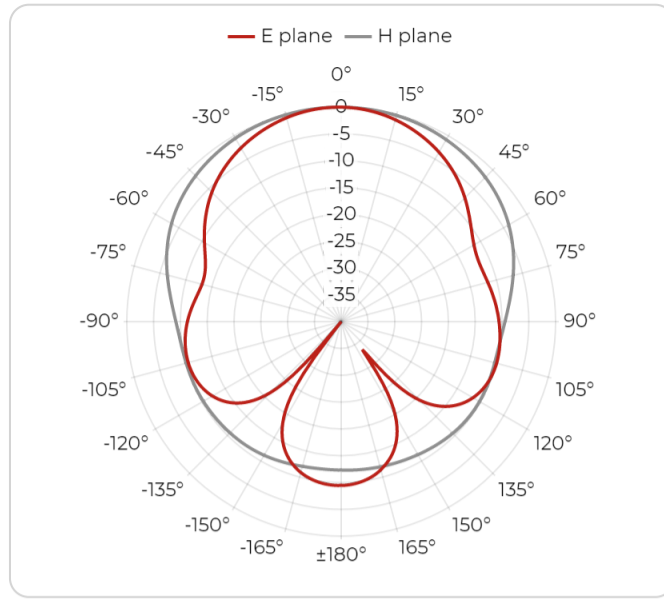

2 GHz

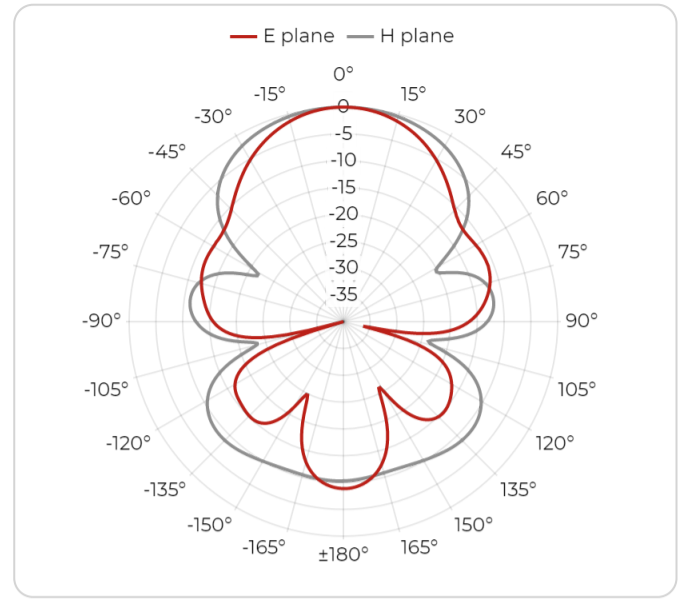

4 GHz

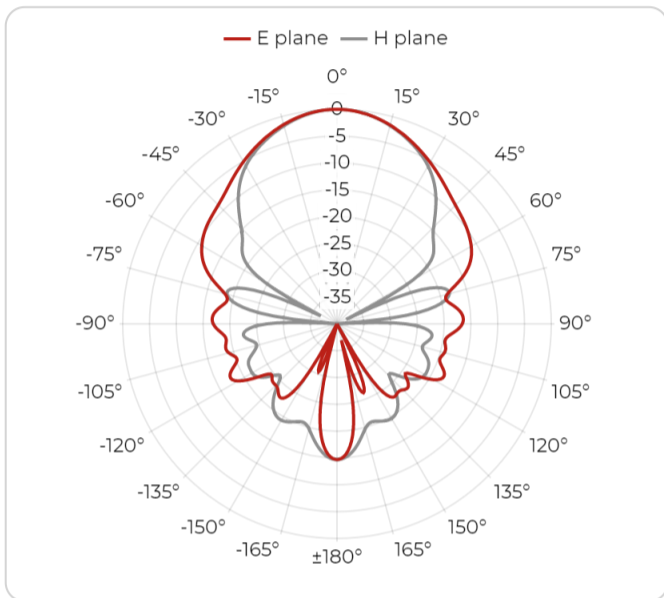

6 GHz

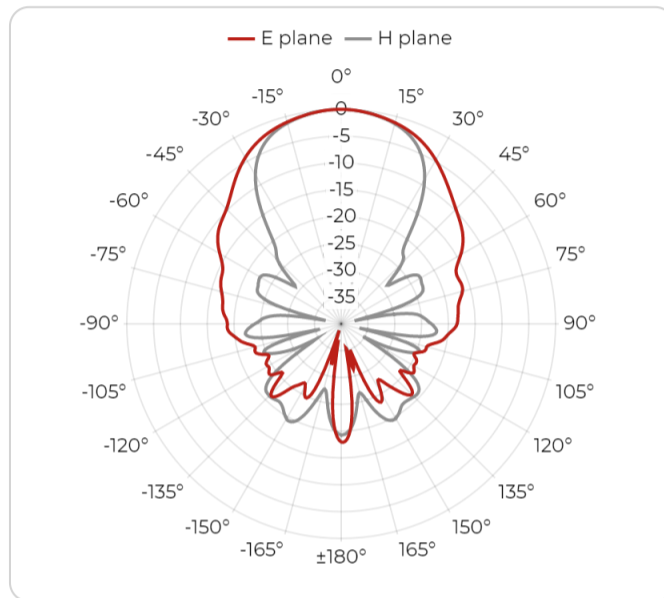

8 GHz

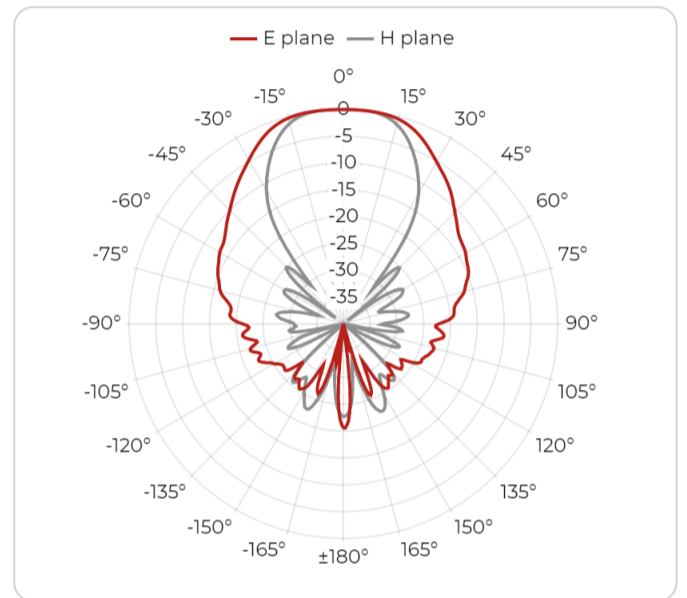

10 GHz

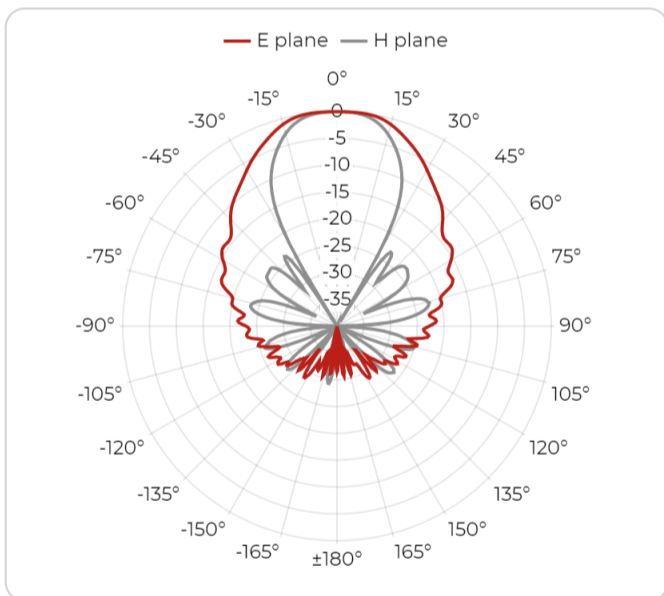

12 GHz

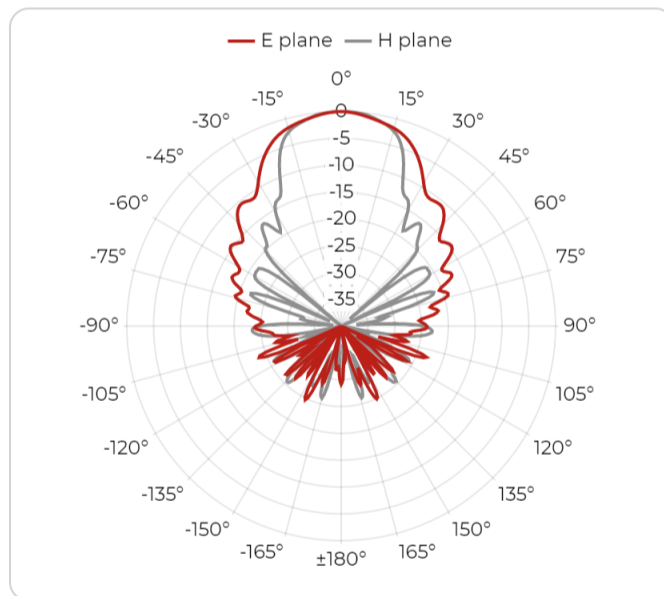

14 GHz

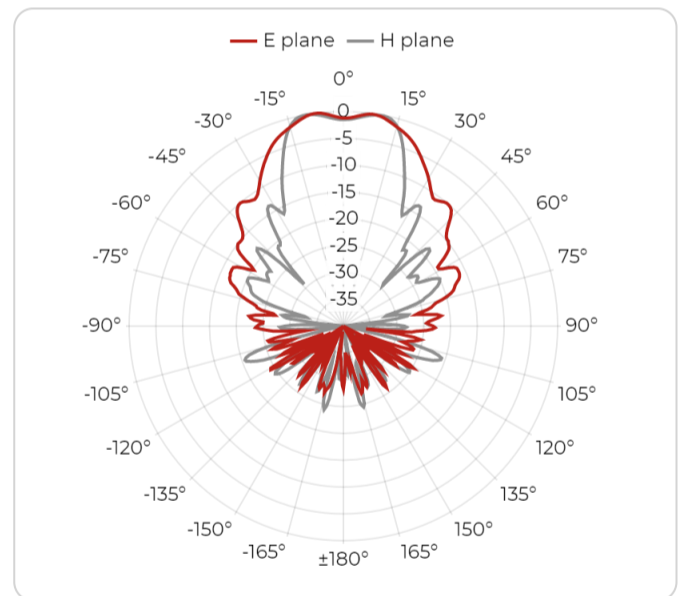

16 GHz

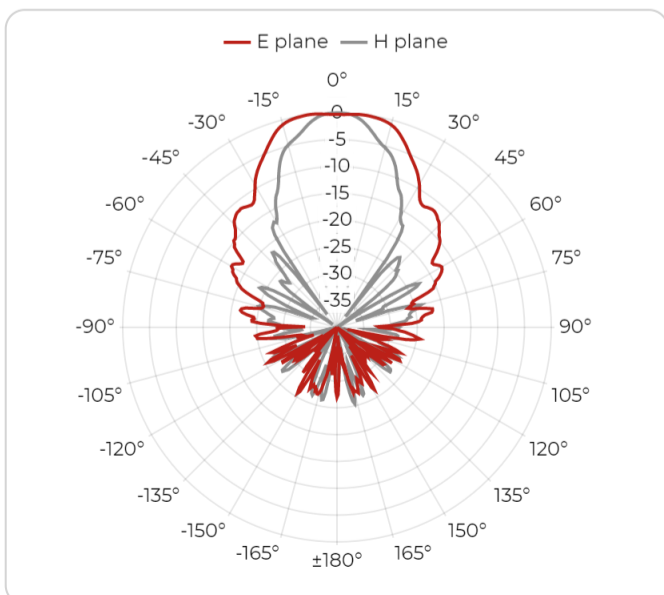

17 GHz

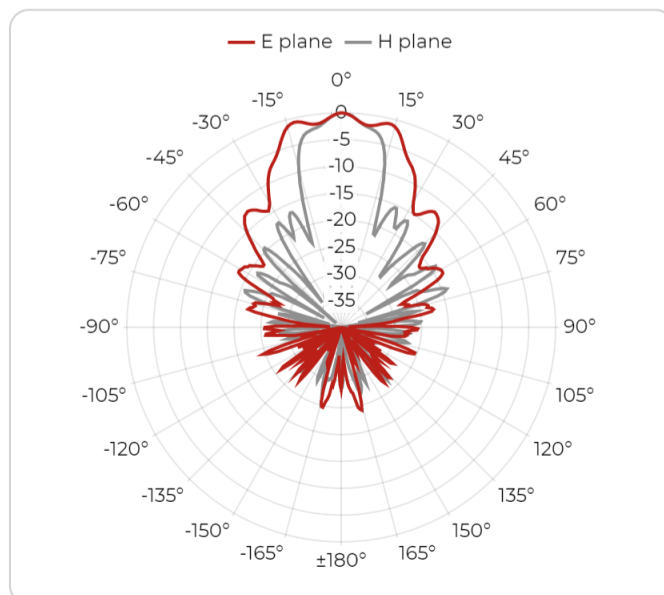

18 GHz

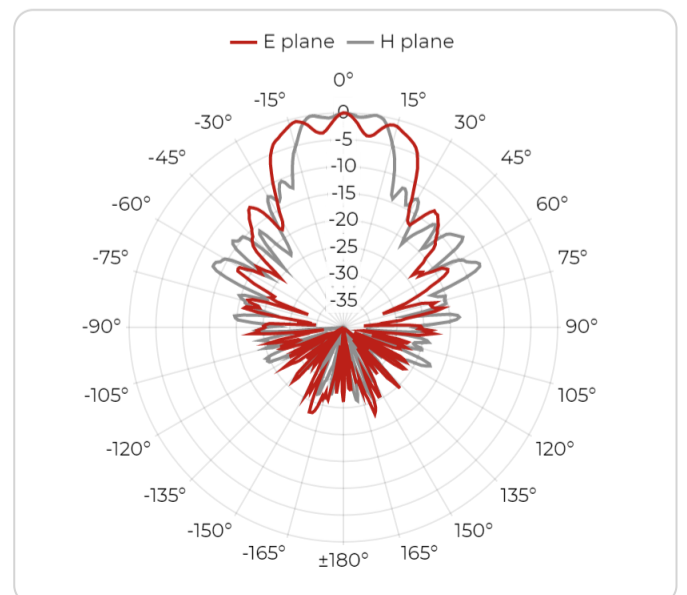

## Packaging and Accessories

### What's in a box

- DRH18-EX Antenna
- Antenna specific mount adapter with ¼ inch inner thread
- Factory calibration certificate
- Full calibration report of each antenna
- QR code accessing online portal
- Calibration test dataset (available online)

### Accessories

- Standard mounting flange

### Optional Accessories

- [AHS22-HI Antenna Fixture](#)
- [PAS02 Antenna Stand](#)

### Custom services

- Custom mounting solutions
- Custom calibration data

## Manufacturer Information

### About Datasheet

Product information available also online at  
<https://www.rfspin.com/product/drh18-ex/>

*Data and specifications subject to change without notice.*

*Datasheet revision 02-2024.*

© RFspin 2024

### 📍 Address

RFspin s.r.o.  
Na Beránce 57/2  
160 00 Prague 6  
Czech Republic

### ✉ E-mail

[info@rfspin.com](mailto:info@rfspin.com)

### 📞 Phone

[+420 245 008 847](tel:+420245008847)