



Test Site: **RF SPIN Factory Laboratory**
Type of Calibration: **Factory Calibration**

RF SPIN

Calibration Certificate

Certificate Number: **CE2D20Q11_Jun23**
Date of Calibration: **27-Jun-2023**
Device Manufacturer: **RF SPIN s.r.o.**
Model Name: **QRH11**
Device Serial Number: **CE2D20Q11**
Calibration Tier: **PLUS**

This certificate and complete antenna data are securely stored on RF SPIN Antenna Portal. To access it, scan the QR code or visit rfspin.com/ap to enter the token.



TEST ITEM	SPECIFIED VALUE	RESULT VALUE	PASS / FAIL
VSWR Port A (max.)	2.40	2.25	PASS
VSWR Port B (max.)	2.40	2.03	PASS
Port Isolation (min.) [dB abs.]	32	36.91	PASS
Quality Control	Visual + dimensional		PASS
Gain Port A [dBi]		3.6 - 13.8	CALIBRATED
Gain Port B [dBi]		3.6 - 15.2	CALIBRATED
Antenna Factor Port A [dB/m]		23.9 - 38.7	CALIBRATED
Antenna Factor Port B [dB/m]		23.9 - 36.7	CALIBRATED

Equipment complied with the specification.

Test Method: **Three Antenna Method**
Measurement Equipment: **Rohde &Schwarz ZVA40**
Environmental Conditions: **Unaccredited anechoic chamber, temperature (22 ±3) °C and humidity <70%.**
Measuring Distance: **3 m**

	NAME	TITLE
Calibrated by	Tomáš Lonský	Technical Expert
Approved by	Zdeněk Hradecký	Owner / Director

RFspin s.r.o.
Na Beránce 57/2
160 00 Praha 6
IČ: 27084990

Date of Issue: **27-Jun-2023**

Stamp/Signature

Description of Device (EUT)

Device type: **Quad Ridged Horn Antenna**
 Model Name: **QRH11**
 Brand Name: **RF SPIN**

Device Serial Number: **CE2D20Q11**
 Manufacturing Date: **Jun-2023**
 Manufacturing Facility: **RF SPIN Nova Paka (CZ)**

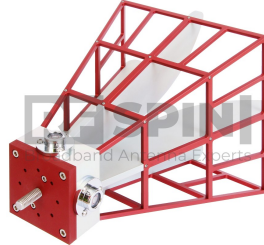

Mechanical Drawings

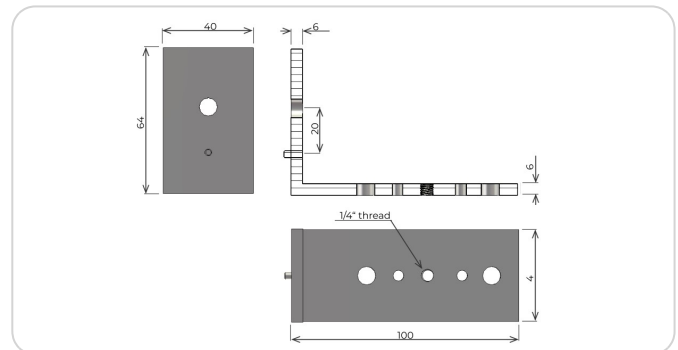
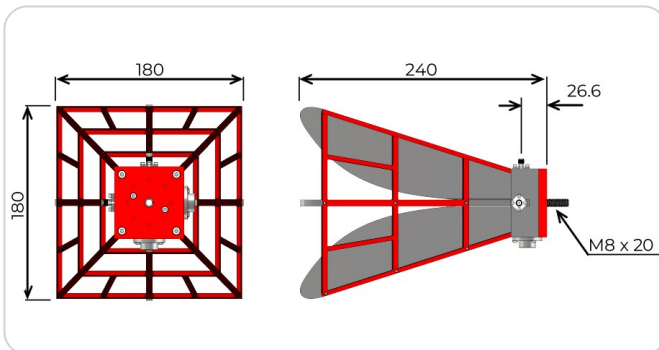

Product Parameters

ELECTRICAL SPECIFICATIONS

Frequency Range	0.73 GHz - 11 GHz
VSWR (max.)	2.4
VSWR (avg.)	1.4
Impedance	50 Ohm
Connector	SMA (female)
Antenna Factor	23 - 38 dB/m
Gain	3 - 15.5 dBi
Port Isolation	-32 dB
Power (CW/Peak)	100 W / 170 W

PHYSICAL SPECIFICATIONS

Width	180 mm (7.087 in)
Height	180 mm (7.087 in)
Depth	240 mm (9.449 in)
Weight	1.03 kg (2.271 lb)

OPERATING CONDITIONS

Operating Temperature	0°C - +50°C
Storage Temperature	-20°C - +70°C

MOUNTING FLANGE

Mounting	Adapter with 1/4 inch inner thread, supplied with antenna
----------	--

Measurement plots - Typical data

Typical data, not per-device. Reference for all QRH11 units — not specific to Serial No.: CE2D20Q11.

Beamwidth

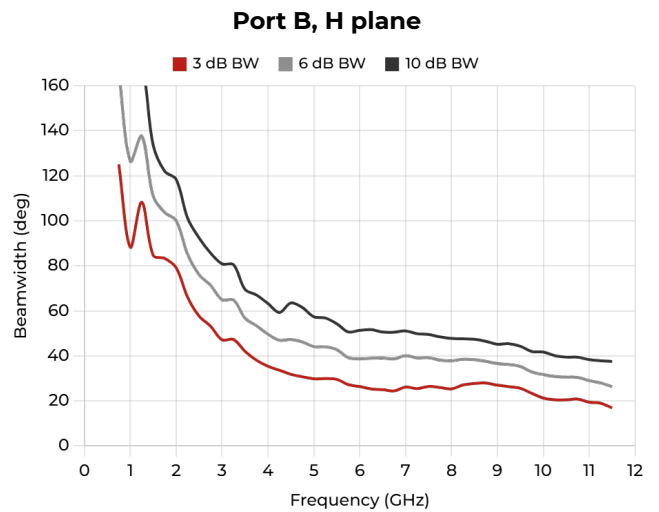
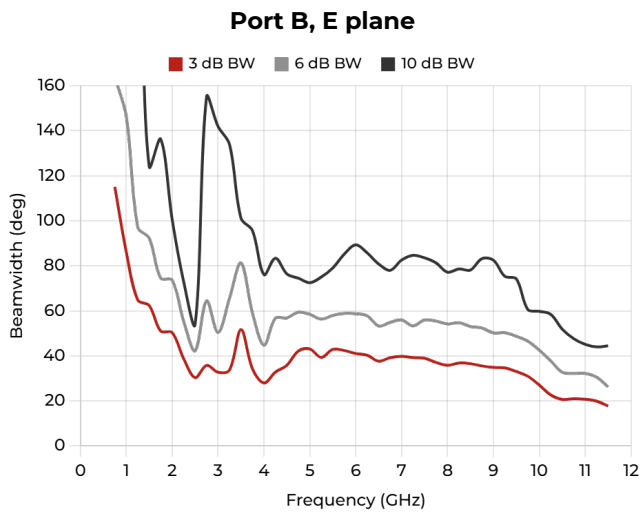
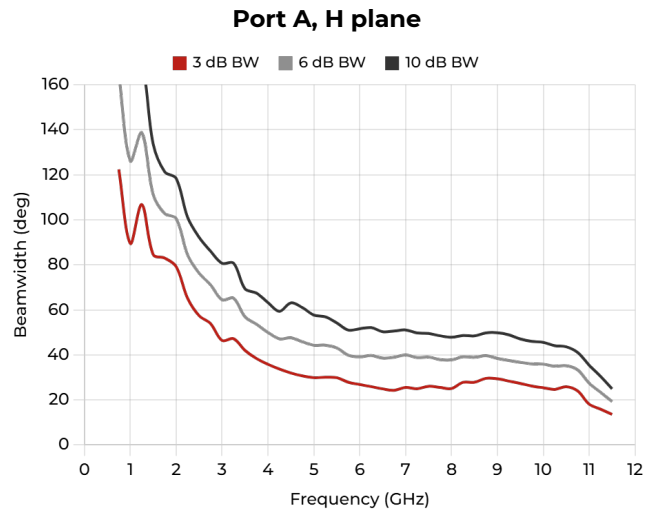
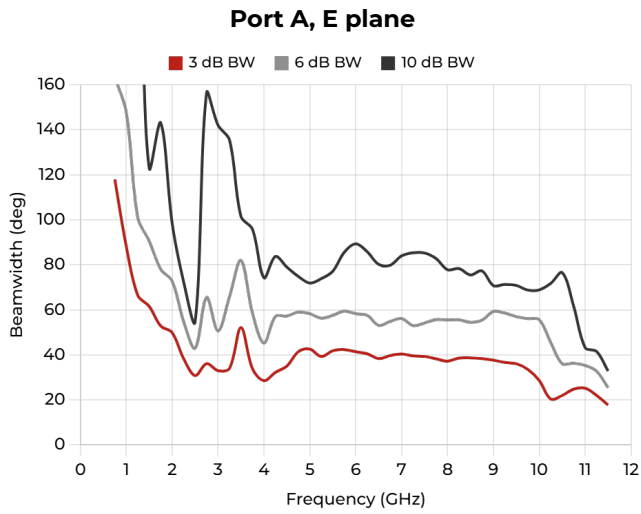

Cross Polarization

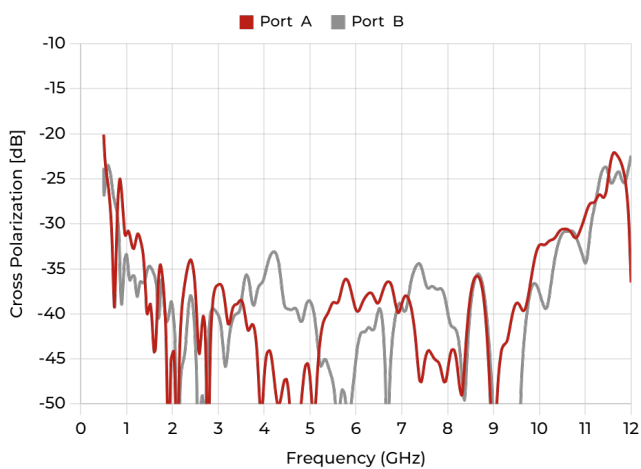

Radiation Patterns – Port A

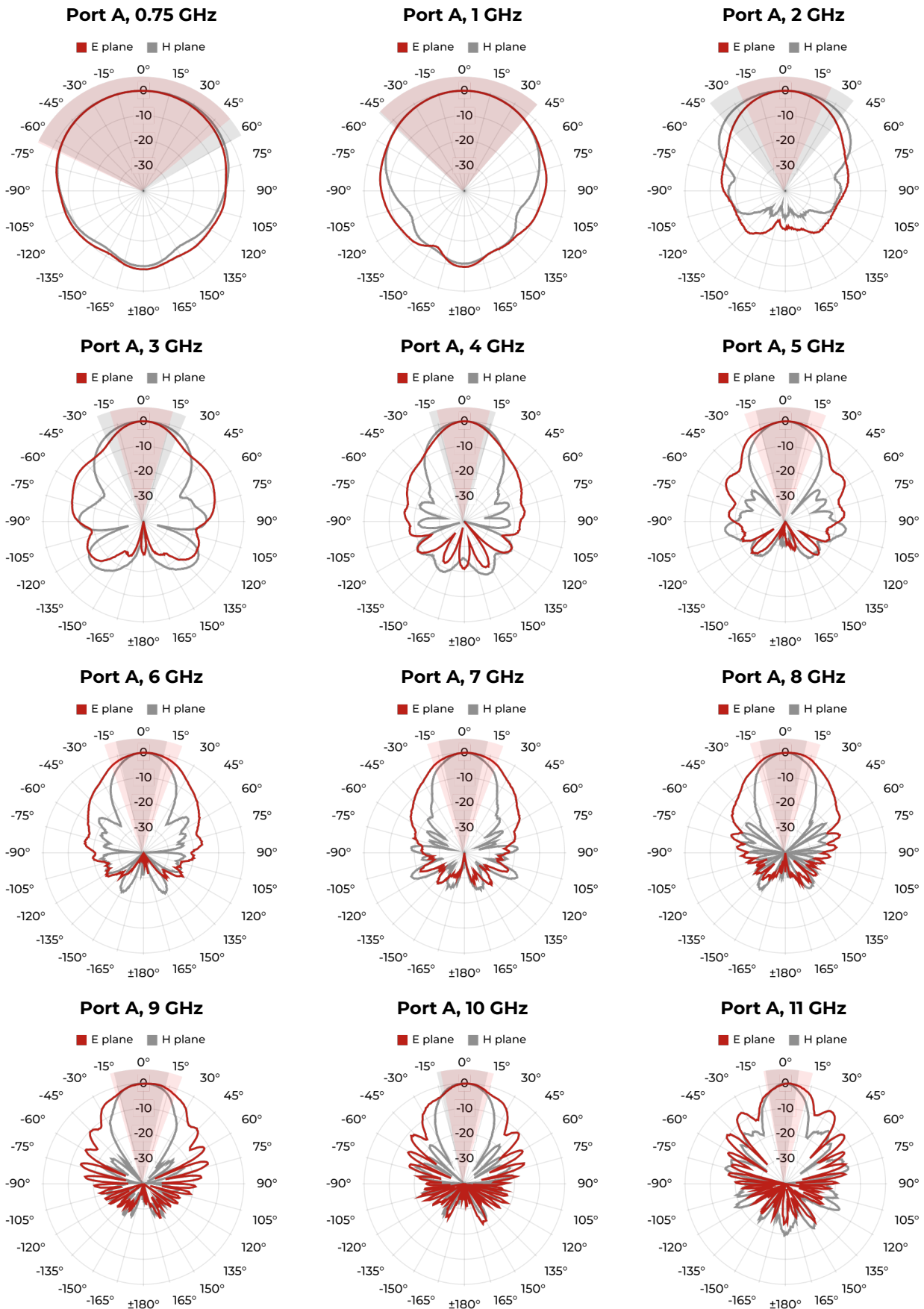

Radiation Patterns – Port B

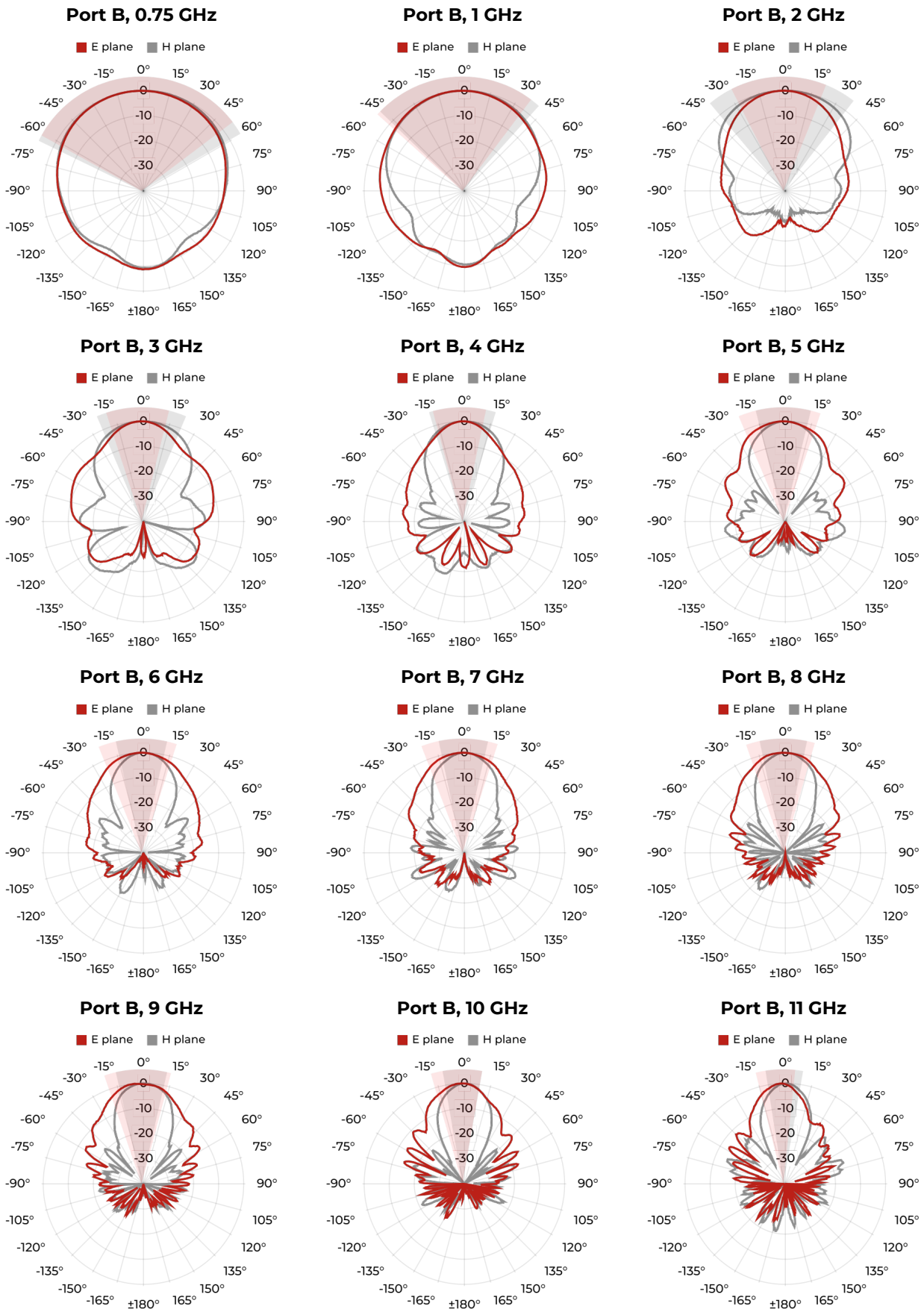

Calibration datasets

Frequency [GHz]	VSWR Port A	VSWR Port B	Frequency [GHz]	Gain Port A [dBi]	Gain Port B [dBi]	Frequency [GHz]	AF Port A [dB/m]	AF Port B [dB/m]	Frequency [GHz]	Port Isolation [dB]
0.60	11.38	9.72	0.60	-1.6	-1.3	0.60	27.4	27.1	0.60	-50.0
0.70	2.61	2.55	0.70	2.7	2.8	0.70	24.4	24.4	0.70	-53.1
0.80	1.22	1.20	0.80	4.4	4.4	0.80	23.9	23.9	0.80	-54.7
0.90	1.73	1.50	0.90	4.8	5.0	0.90	24.5	24.4	0.90	-47.0
1.00	1.49	1.32	1.00	5.9	6.0	1.00	24.3	24.3	1.00	-42.9
1.10	1.25	1.18	1.10	6.0	6.0	1.10	25.1	25.1	1.10	-59.7
1.20	2.07	1.89	1.20	4.7	4.8	1.20	27.1	27.0	1.20	-47.0
1.30	2.11	1.88	1.30	5.1	5.3	1.30	27.4	27.3	1.30	-61.6
1.40	1.73	1.54	1.40	6.4	6.5	1.40	26.8	26.7	1.40	-51.9
1.50	1.69	1.51	1.50	7.1	7.2	1.50	26.7	26.6	1.50	-48.1
1.60	1.80	1.62	1.60	7.2	7.4	1.60	27.1	27.0	1.60	-47.4
1.70	1.90	1.70	1.70	6.4	6.6	1.70	28.4	28.3	1.70	-52.2
1.80	1.71	1.53	1.80	7.3	7.3	1.80	28.1	28.0	1.80	-48.1
1.90	1.56	1.40	1.90	8.0	8.0	1.90	27.9	27.8	1.90	-53.0
2.00	1.37	1.22	2.00	8.0	8.1	2.00	28.2	28.2	2.00	-50.4
2.10	1.58	1.42	2.10	8.8	8.9	2.10	27.9	27.8	2.10	-49.6
2.20	1.77	1.59	2.20	9.3	9.4	2.20	27.8	27.7	2.20	-47.5
2.30	1.72	1.58	2.30	9.8	9.9	2.30	27.7	27.6	2.30	-47.4
2.40	1.50	1.47	2.40	10.3	10.3	2.40	27.5	27.5	2.40	-49.6
2.50	1.26	1.38	2.50	10.6	10.5	2.50	27.6	27.7	2.50	-50.8
2.60	1.22	1.32	2.60	10.3	10.2	2.60	28.2	28.3	2.60	-54.5
2.70	1.26	1.27	2.70	10.0	10.0	2.70	28.8	28.9	2.70	-48.3
2.80	1.30	1.24	2.80	10.3	10.3	2.80	28.9	28.9	2.80	-48.2
2.90	1.29	1.17	2.90	10.7	10.8	2.90	28.8	28.7	2.90	-48.0
3.00	1.20	1.05	3.00	11.1	11.1	3.00	28.7	28.7	3.00	-48.9
3.10	1.06	1.09	3.10	11.3	11.2	3.10	28.8	28.9	3.10	-49.8
3.20	1.17	1.23	3.20	11.0	11.0	3.20	29.3	29.4	3.20	-48.1
3.30	1.34	1.29	3.30	10.8	10.8	3.30	29.9	29.8	3.30	-47.0
3.40	1.41	1.24	3.40	10.6	10.7	3.40	30.3	30.2	3.40	-46.2
3.50	1.40	1.20	3.50	10.8	10.9	3.50	30.4	30.3	3.50	-44.9
3.60	1.34	1.18	3.60	11.3	11.3	3.60	30.1	30.1	3.60	-44.0
3.70	1.23	1.19	3.70	11.8	11.8	3.70	29.8	29.9	3.70	-46.0
3.80	1.08	1.21	3.80	12.2	12.2	3.80	29.6	29.7	3.80	-46.9
3.90	1.09	1.18	3.90	12.4	12.4	3.90	29.6	29.7	3.90	-46.8
4.00	1.26	1.12	4.00	12.4	12.4	4.00	29.9	29.9	4.00	-44.4
4.10	1.32	1.12	4.10	12.3	12.4	4.10	30.2	30.1	4.10	-43.2
4.20	1.27	1.15	4.20	12.3	12.3	4.20	30.4	30.4	4.20	-44.6
4.30	1.18	1.17	4.30	12.3	12.3	4.30	30.6	30.6	4.30	-44.9
4.40	1.08	1.16	4.40	12.3	12.2	4.40	30.9	30.9	4.40	-45.1
4.50	1.07	1.11	4.50	12.2	12.2	4.50	31.1	31.1	4.50	-45.2
4.60	1.15	1.05	4.60	12.2	12.2	4.60	31.3	31.3	4.60	-45.0

4.70	1.18	1.02	4.70	12.2	12.2	4.70	31.5	31.5	4.70	-44.4
4.80	1.17	1.01	4.80	12.2	12.2	4.80	31.7	31.7	4.80	-43.6
4.90	1.15	1.03	4.90	12.2	12.2	4.90	31.8	31.8	4.90	-43.7
5.00	1.17	1.07	5.00	12.4	12.4	5.00	31.9	31.9	5.00	-44.1
5.10	1.24	1.11	5.10	12.5	12.5	5.10	31.9	31.9	5.10	-43.9
5.20	1.29	1.14	5.20	12.6	12.6	5.20	32.0	32.0	5.20	-43.5
5.30	1.30	1.14	5.30	12.5	12.6	5.30	32.2	32.1	5.30	-42.9
5.40	1.28	1.11	5.40	12.5	12.5	5.40	32.4	32.4	5.40	-42.7
5.50	1.23	1.06	5.50	12.4	12.5	5.50	32.7	32.6	5.50	-42.7
5.60	1.20	1.05	5.60	12.4	12.5	5.60	32.8	32.7	5.60	-42.9
5.70	1.20	1.07	5.70	12.5	12.6	5.70	32.8	32.8	5.70	-42.9
5.80	1.20	1.08	5.80	12.6	12.6	5.80	32.9	32.9	5.80	-42.6
5.90	1.19	1.05	5.90	12.6	12.6	5.90	33.1	33.1	5.90	-42.3
6.00	1.14	1.06	6.00	12.5	12.6	6.00	33.3	33.3	6.00	-42.3
6.10	1.09	1.11	6.10	12.6	12.5	6.10	33.4	33.4	6.10	-42.5
6.20	1.09	1.17	6.20	12.6	12.6	6.20	33.5	33.5	6.20	-42.8
6.30	1.11	1.20	6.30	12.8	12.7	6.30	33.5	33.6	6.30	-42.8
6.40	1.14	1.21	6.40	12.9	12.9	6.40	33.5	33.5	6.40	-42.7
6.50	1.14	1.19	6.50	13.0	13.0	6.50	33.5	33.5	6.50	-42.3
6.60	1.11	1.19	6.60	13.0	13.0	6.60	33.6	33.6	6.60	-41.4
6.70	1.09	1.23	6.70	12.9	13.0	6.70	33.8	33.8	6.70	-41.4
6.80	1.11	1.26	6.80	12.9	12.9	6.80	34.0	34.0	6.80	-41.9
6.90	1.15	1.27	6.90	12.9	12.9	6.90	34.2	34.2	6.90	-42.1
7.00	1.16	1.25	7.00	12.8	12.8	7.00	34.3	34.3	7.00	-42.0
7.10	1.16	1.22	7.10	12.8	12.8	7.10	34.5	34.4	7.10	-41.9
7.20	1.14	1.19	7.20	12.8	12.9	7.20	34.6	34.5	7.20	-41.8
7.30	1.12	1.18	7.30	12.9	12.9	7.30	34.6	34.6	7.30	-41.8
7.40	1.12	1.19	7.40	12.9	13.0	7.40	34.7	34.7	7.40	-41.8
7.50	1.12	1.18	7.50	12.9	12.9	7.50	34.9	34.8	7.50	-41.6
7.60	1.12	1.16	7.60	12.9	12.9	7.60	35.0	35.0	7.60	-41.5
7.70	1.10	1.14	7.70	13.0	13.1	7.70	35.0	34.9	7.70	-41.4
7.80	1.08	1.14	7.80	13.2	13.3	7.80	34.9	34.8	7.80	-41.5
7.90	1.04	1.16	7.90	13.4	13.4	7.90	34.8	34.8	7.90	-41.7
8.00	1.02	1.18	8.00	13.4	13.4	8.00	34.9	34.9	8.00	-41.8
8.10	1.04	1.20	8.10	13.3	13.3	8.10	35.1	35.1	8.10	-41.9
8.20	1.05	1.21	8.20	13.2	13.2	8.20	35.3	35.4	8.20	-41.8
8.30	1.06	1.21	8.30	13.2	13.2	8.30	35.4	35.5	8.30	-41.8
8.40	1.08	1.23	8.40	13.3	13.2	8.40	35.5	35.5	8.40	-41.9
8.50	1.11	1.26	8.50	13.3	13.3	8.50	35.5	35.6	8.50	-42.1
8.60	1.14	1.30	8.60	13.3	13.2	8.60	35.6	35.7	8.60	-42.3
8.70	1.17	1.32	8.70	13.2	13.2	8.70	35.8	35.8	8.70	-42.4
8.80	1.19	1.34	8.80	13.1	13.2	8.80	36.1	36.0	8.80	-42.3
8.90	1.20	1.35	8.90	13.0	13.2	8.90	36.3	36.1	8.90	-42.4
9.00	1.21	1.36	9.00	12.9	13.3	9.00	36.4	36.1	9.00	-43.0
9.10	1.21	1.39	9.10	12.9	13.4	9.10	36.5	36.1	9.10	-43.5

9.20	1.22	1.42	9.20	12.9	13.4	9.20	36.6	36.1	9.20	-43.5
9.30	1.22	1.44	9.30	13.0	13.5	9.30	36.7	36.1	9.30	-43.4
9.40	1.22	1.44	9.40	13.1	13.6	9.40	36.6	36.1	9.40	-43.5
9.50	1.22	1.43	9.50	13.3	13.8	9.50	36.5	36.0	9.50	-43.5
9.60	1.23	1.43	9.60	13.4	13.9	9.60	36.5	36.0	9.60	-43.2
9.70	1.27	1.43	9.70	13.6	14.1	9.70	36.4	35.9	9.70	-42.2
9.80	1.32	1.41	9.80	13.7	14.4	9.80	36.4	35.7	9.80	-41.4
9.90	1.37	1.40	9.90	13.8	14.6	9.90	36.4	35.5	9.90	-40.9
10.00	1.43	1.39	10.00	13.7	14.7	10.00	36.5	35.5	10.00	-40.6
10.10	1.49	1.40	10.10	13.7	14.9	10.10	36.7	35.5	10.10	-40.3
10.20	1.55	1.41	10.20	13.6	15.0	10.20	36.8	35.4	10.20	-39.9
10.30	1.56	1.43	10.30	13.4	15.1	10.30	37.1	35.4	10.30	-39.1
10.40	1.53	1.44	10.40	13.0	15.2	10.40	37.6	35.4	10.40	-38.7
10.50	1.48	1.44	10.50	12.6	15.1	10.50	38.1	35.6	10.50	-38.7
10.60	1.46	1.43	10.60	12.2	14.9	10.60	38.5	35.9	10.60	-39.0
10.70	1.46	1.42	10.70	12.2	14.6	10.70	38.7	36.2	10.70	-38.9
10.80	1.49	1.43	10.80	12.4	14.4	10.80	38.5	36.5	10.80	-38.5
10.90	1.53	1.47	10.90	12.9	14.4	10.90	38.1	36.6	10.90	-37.8
11.00	1.59	1.51	11.00	13.3	14.3	11.00	37.8	36.8	11.00	-36.9
11.10	1.67	1.55	11.10	13.5	14.2	11.10	37.6	37.0	11.10	-36.3
11.20	1.80	1.59	11.20	13.7	14.0	11.20	37.5	37.2	11.20	-35.3