



The DRH50 antenna combines small dimensions with high accuracy and perfect electrical parameters. For safe storage, it is placed in a tailor-made wooden box, which guarantees that your antenna will always be in the best condition.

Cloned antenna series are available through **AU Technology**, which guarantees constant parameters.

Manufactured with RF SPIN's **SPM Technology** to achieve the best mechanical and radio parameters.

Features and Specifications



Technical Performance

- Wide bandwidth
- Low return loss
- Individual calibration
- Covers 5G frequency band



Design and Surface Treatment

- Corrosion-resistant coating
- Includes standard mount
- Storage in protective tailor-made wooden box



Manufacturing Technology

- Manufactured using a high grade aluminum alloy
- Extremely durable
- High quality 2.40mm type coaxial connector



Product Packaging Includes

- Adapter with ¼ inch inner thread, supplied with antenna
- Linear polarized double ridged broadband horn antenna

Product Parameters

PRODUCT IDENTIFICATION

Product Name	DRH50
Product Category	Double Ridged Horn Antenna

ELECTRICAL SPECIFICATIONS

Frequency Range	4.5 GHz – 50 GHz
VSWR (max.)	1.55
VSWR (avg.)	1.25
Impedance	50 Ohm
Connector	2.40mm (female)
Power (CW / Peak)	10 W / 20 W
Antenna Factor	36 – 49 dB/m
Polarization	Linear

PHYSICAL SPECIFICATIONS

Width	43.6 mm (1.717 in)
Height	60 mm (2.362 in)
Depth	37.7 mm (1.484 in)
Weight	0.07 kg (0.154 lb)

OPERATING CONDITIONS

Rated Temperature Range	0°C – +50°C
Storage Temperature Range	-20°C – +70°C

MOUNTING FLANGE

Mounting	Adapter with ¼ inch inner thread, supplied with antenna
----------	--

Mechanical Drawings

Antenna

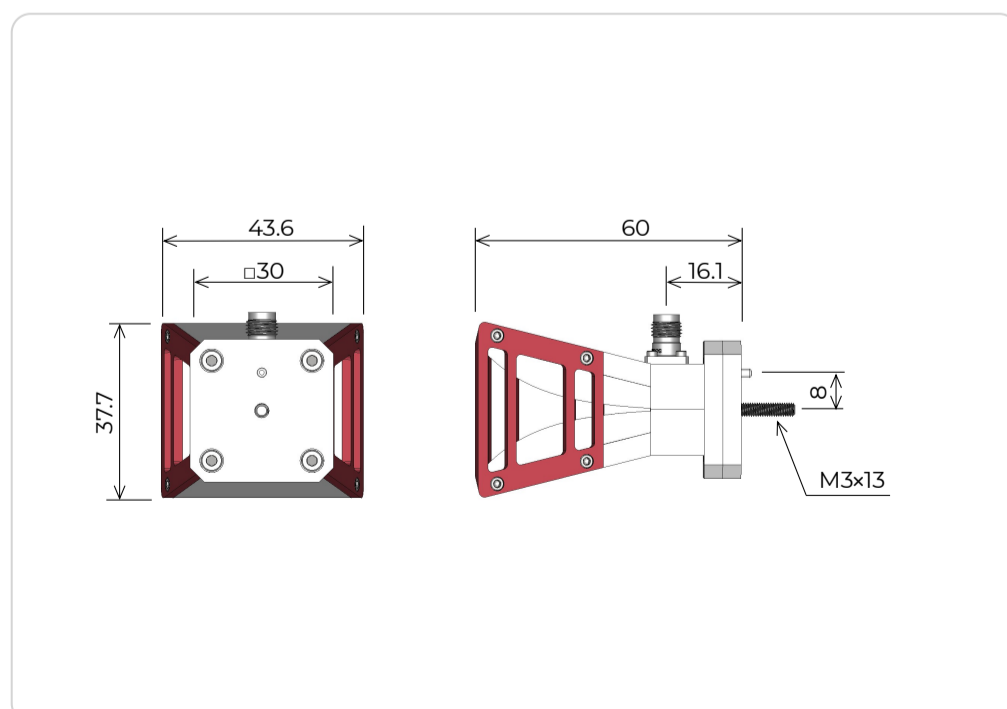

Mounting flange

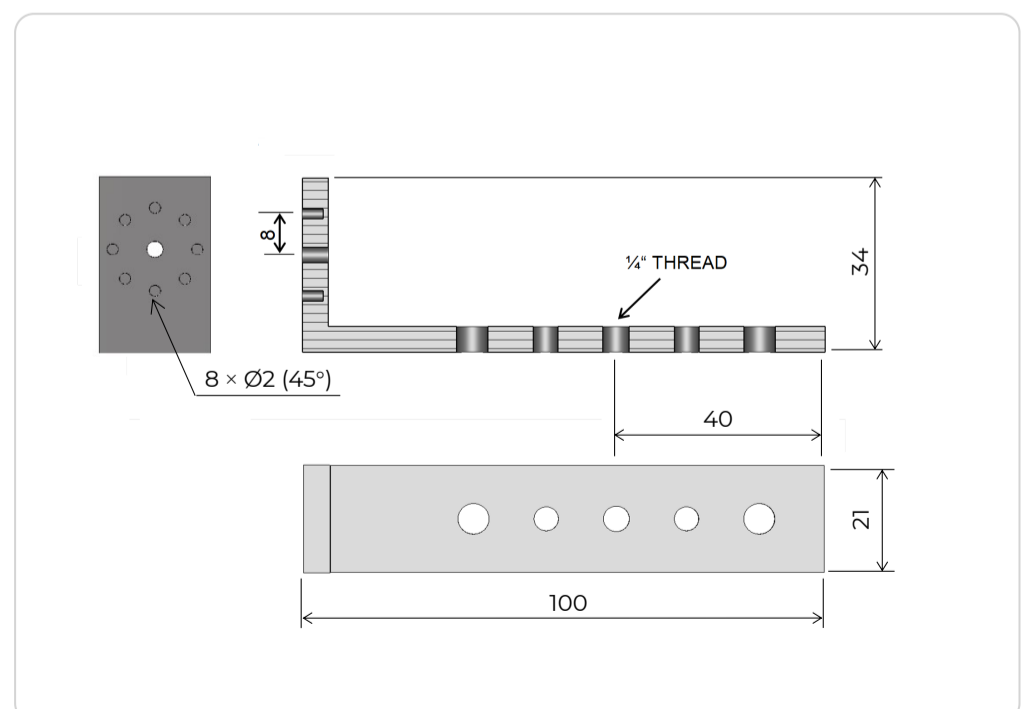

Parameters and Performance

Typical parameters

VSWR

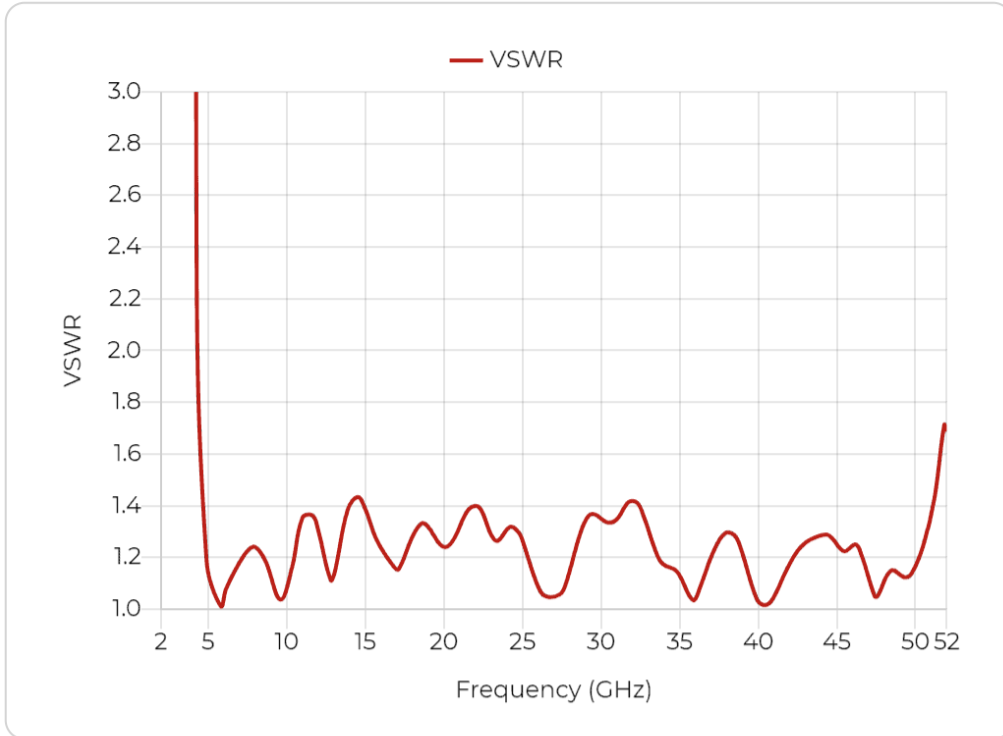

Gain

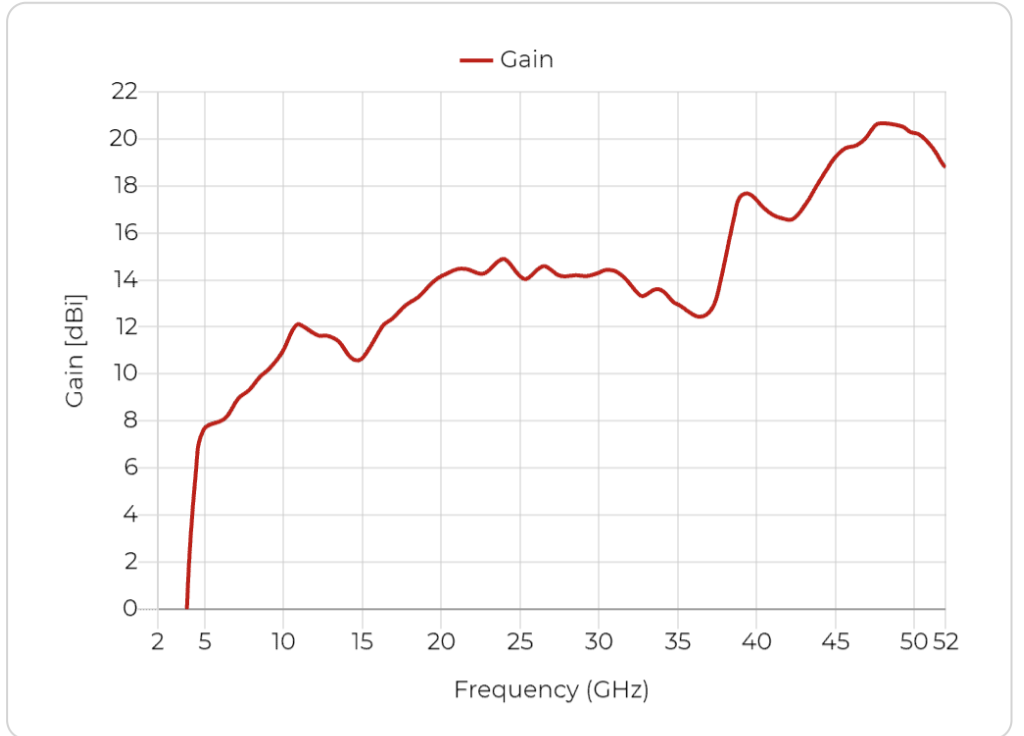

Antenna Factor

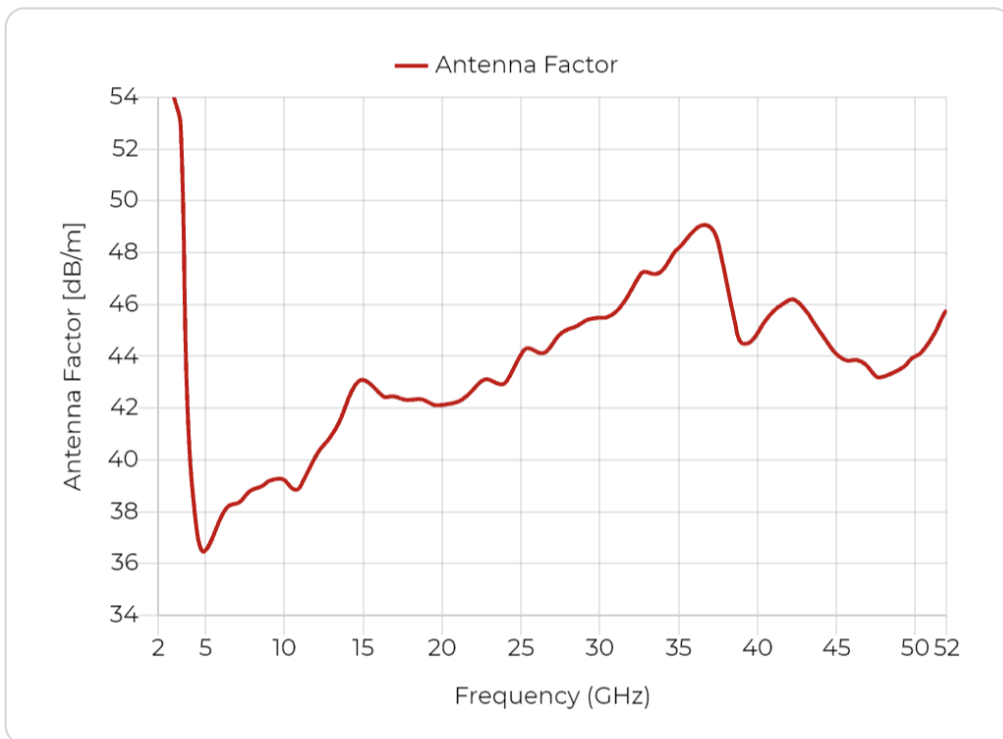

Cross Polarization

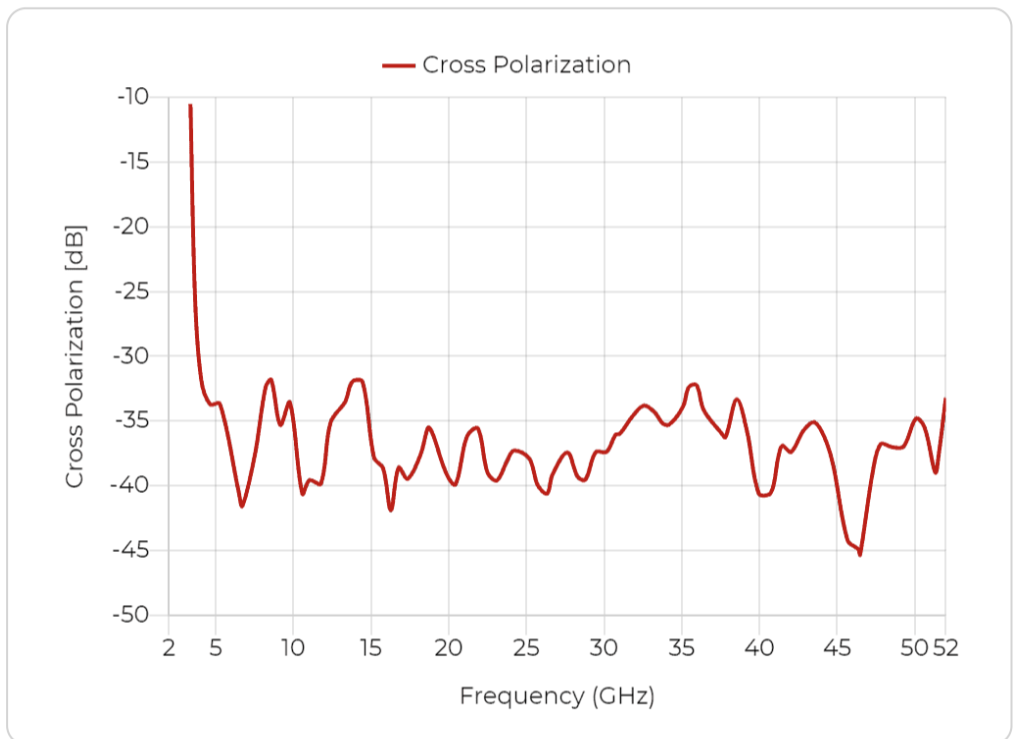

Beamwidth

Port A, E plane

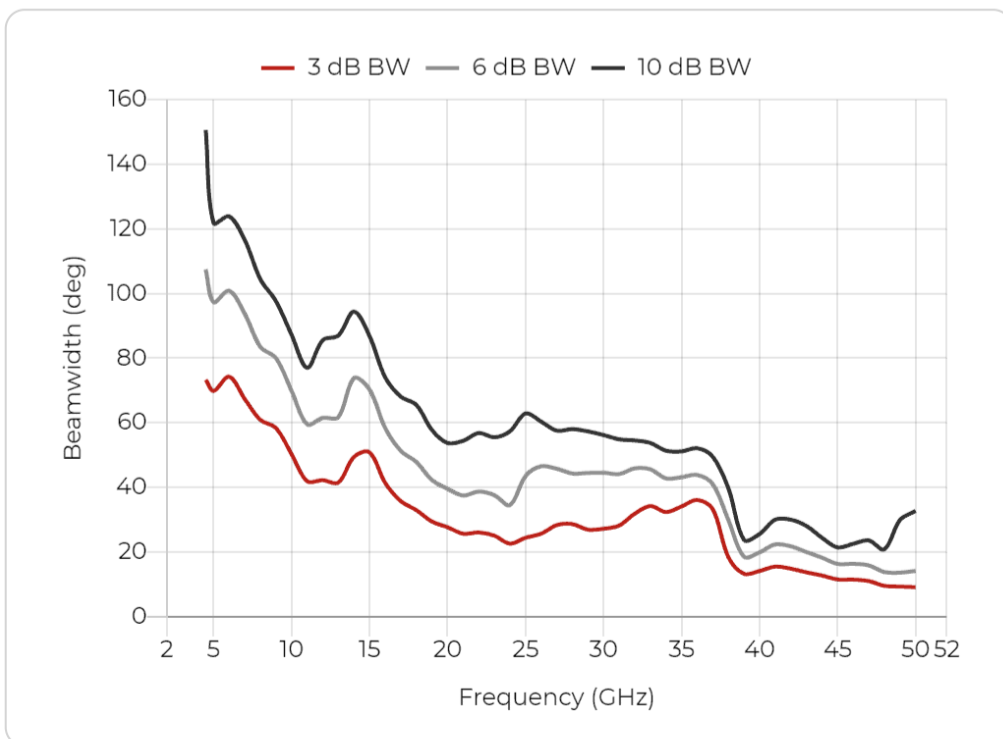

Port A, H plane

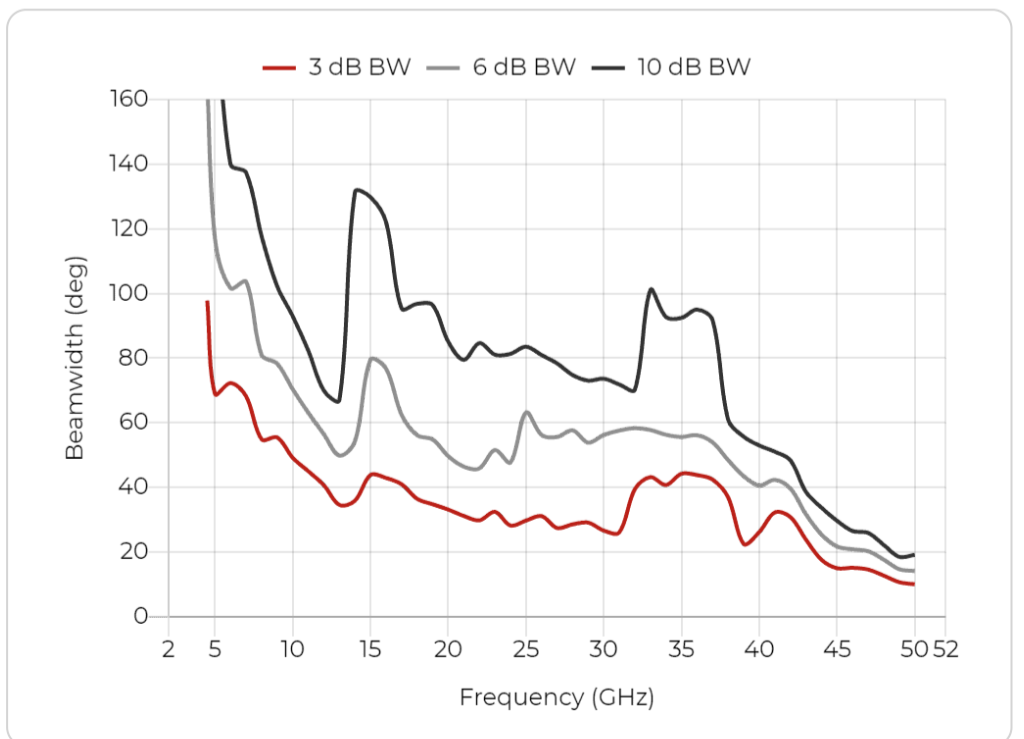

Radiation Patterns

4.5 GHz

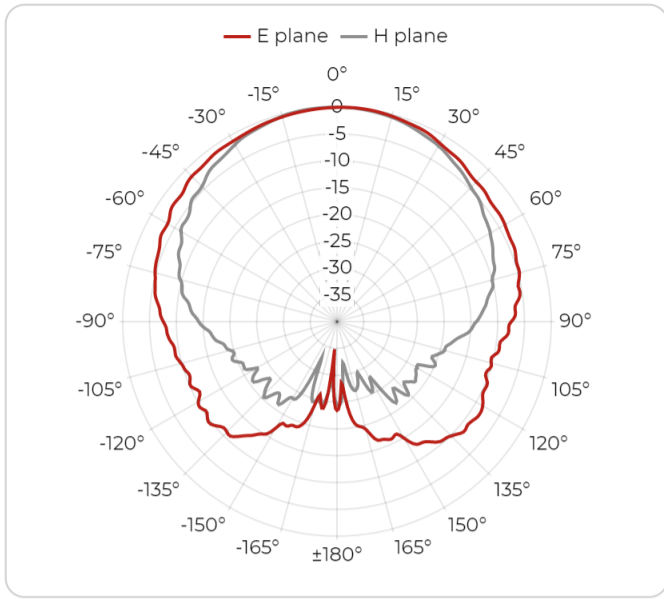

6 GHz

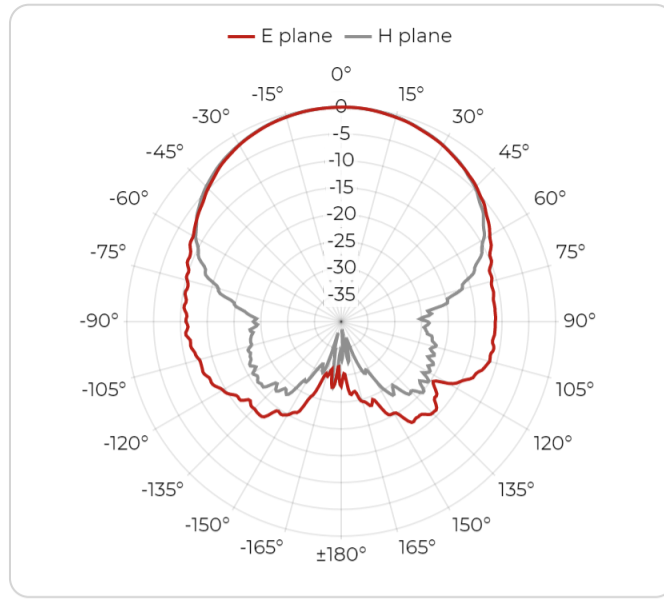

8 GHz

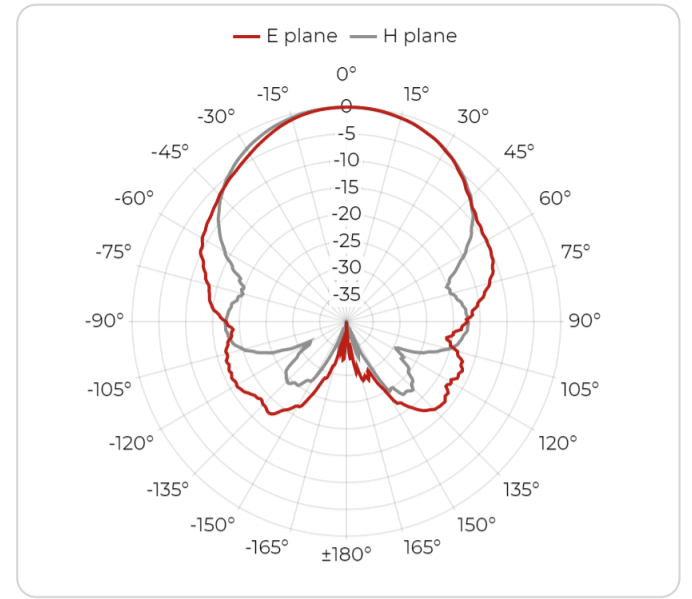

10 GHz

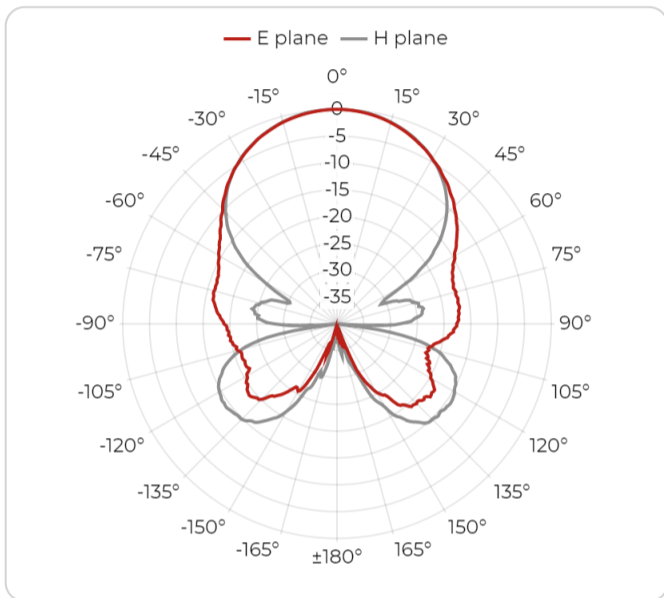

15 GHz

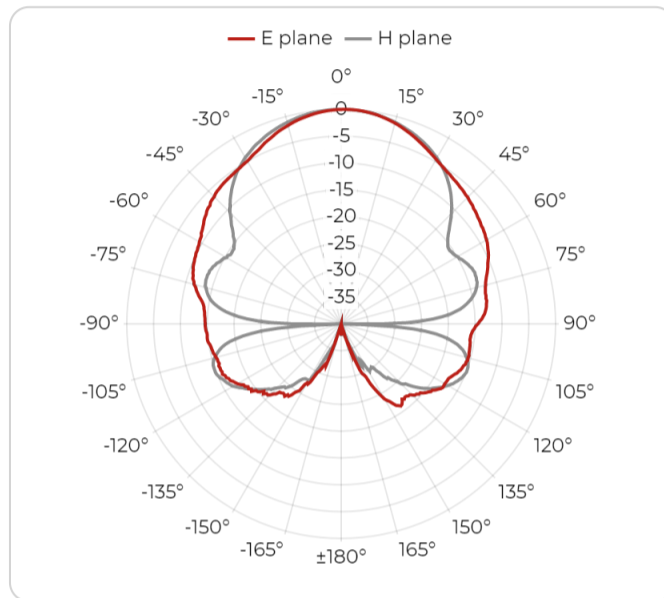

20 GHz

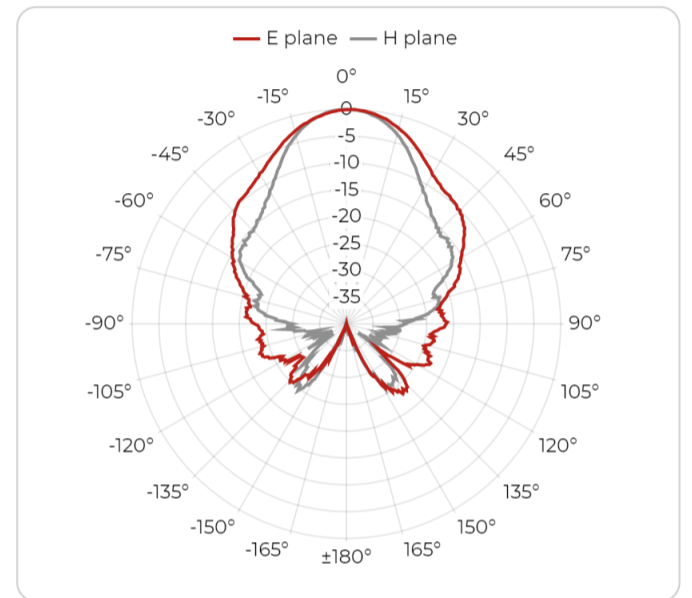

25 GHz

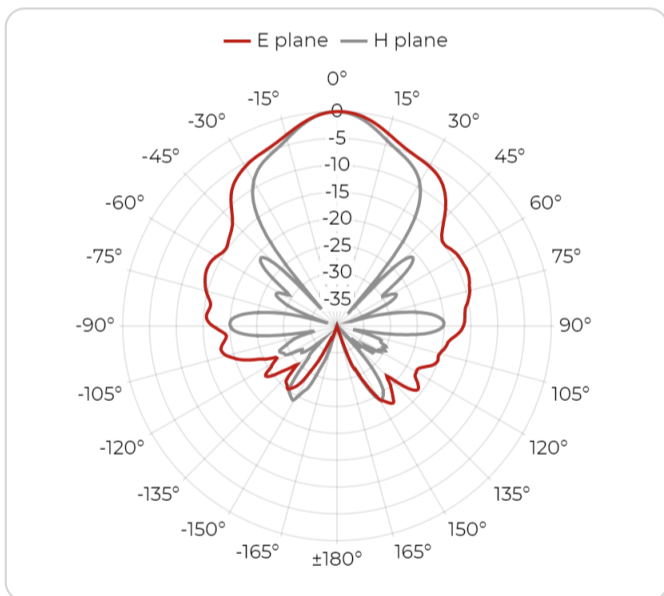

30 GHz

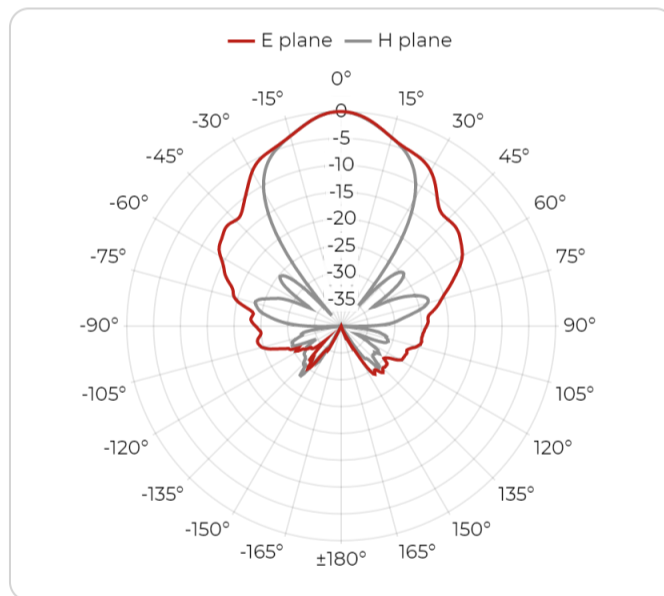

35 GHz

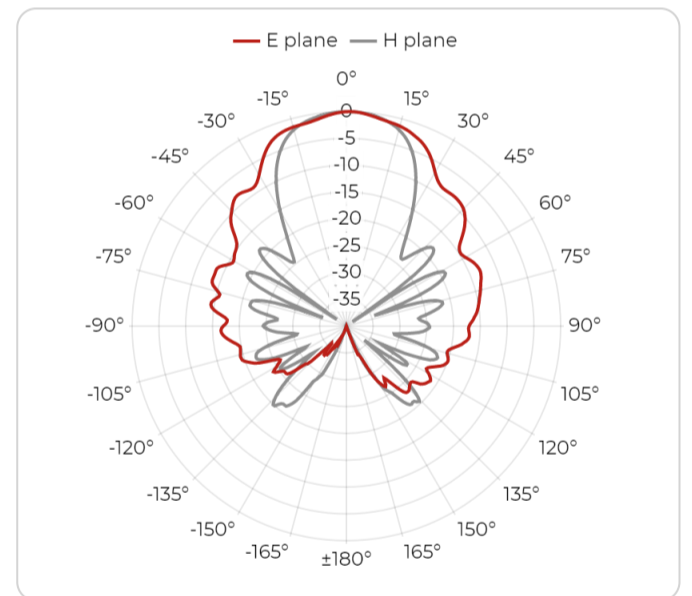

40 GHz

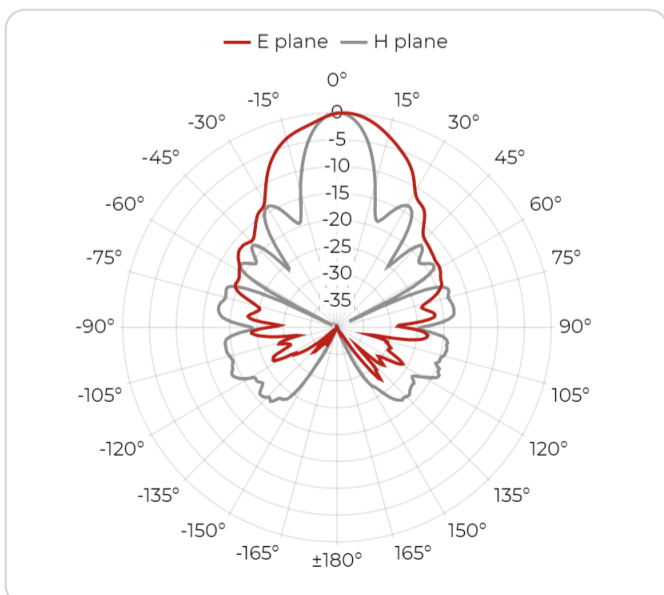

45 GHz

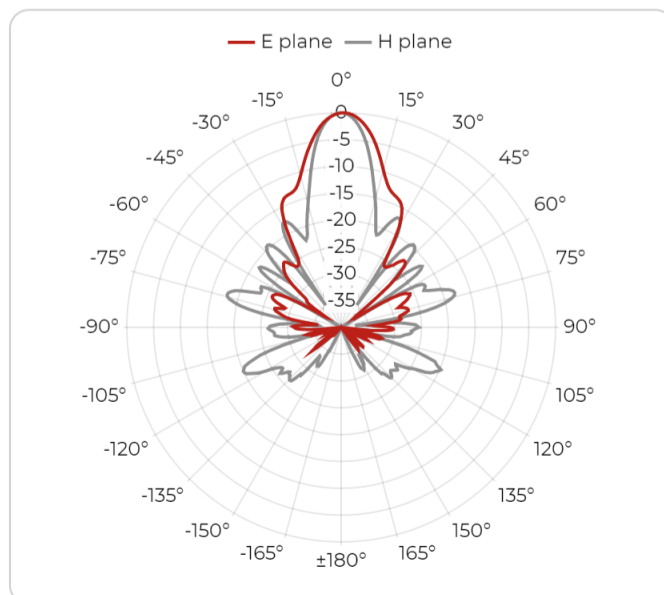

50 GHz

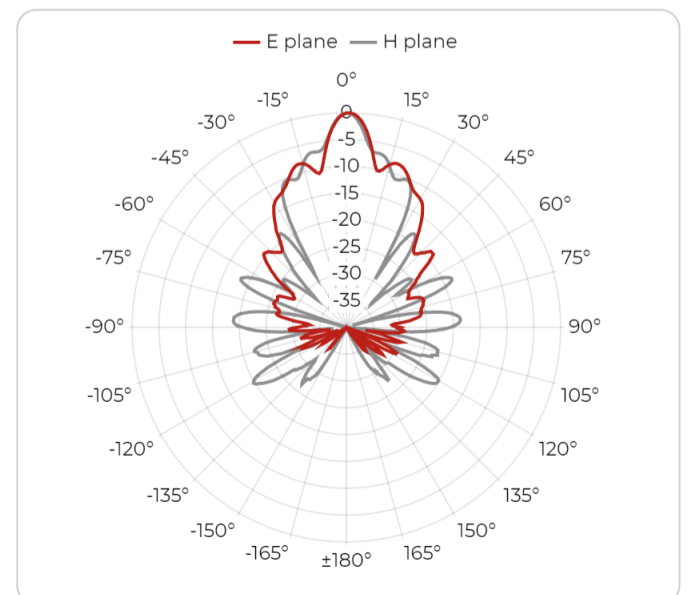

Packaging and Accessories

What's in a box

- DRH50 Antenna
- Antenna specific mount adapter with ¼ inch inner thread
- Protective wooden case
- Factory calibration certificate
- Full calibration report of each antenna
- QR code accessing online portal
- Calibration test dataset (available online)

Accessories

- Standard mounting flange

Optional Accessories

- [AHS2022-14 Antenna Fixture](#)
- [AHS22-HI Antenna Fixture](#)
- [PAS2022 Antenna Stand](#)

Custom services

- Custom mounting solutions
- Custom calibration data

Manufacturer Information

About Datasheet

Product information available also online at
<https://www.rfspin.com/product/drh50/>

Data and specifications subject to change without notice.

Datasheet revision 02-2024.

© RFspin 2024

📍 Address

RFspin s.r.o.
Na Beránce 57/2
160 00 Prague 6
Czech Republic

✉ E-mail

info@rfspin.com

📞 Phone

[+420 245 008 847](tel:+420245008847)