



The QRH40 antenna combines small dimensions with high accuracy and perfect electrical parameters. For safe storage, it is placed in a tailor-made wooden box, which guarantees that your antenna will always be in the best condition.

Cloned antenna series are available through **AU Technology**, which guarantees constant parameters.

Manufactured with RF SPIN's **SPM Technology** to achieve the best mechanical and radio parameters.

Features and Specifications



Technical Performance

- Wide bandwidth
- Low return loss
- Individual calibration
- Covers 5G frequency band



Design and Surface Treatment

- Corrosion-resistant coating
- Includes standard mount
- Storage in protective tailor-made wooden box



Manufacturing Technology

- Manufactured using a high grade aluminum alloy
- Extremely durable
- High quality K type coaxial connector



Product Packaging Includes

- Adapter with 1/4 inch inner thread, supplied with antenna
- Linear polarized double ridged broadband horn antenna

Product Parameters

PRODUCT IDENTIFICATION

Product Name	QRH40
Product Category	Quad Ridged Horn Antenna

ELECTRICAL SPECIFICATIONS

Frequency Range	4 GHz – 40 GHz
VSWR (max.)	2.4
VSWR (avg.)	1.4
Impedance	50 Ohm
Connector	K (female)
Power (CW / Peak)	10 W / 20 W
Antenna Factor	35 – 49 dB/m
Port Isolation	-28 dB
Polarization	Dual Linear, Circular (with hybrid)

PHYSICAL SPECIFICATIONS

Width	53 mm (2.087 in)
Height	68 mm (2.677 in)
Depth	53 mm (2.087 in)
Weight	0.068 kg (0.150 lb)

OPERATING CONDITIONS

Rated Temperature Range	0°C – +50°C
Storage Temperature Range	-20°C – +70°C

MOUNTING FLANGE

Mounting	Adapter with 1/4 inch inner thread, supplied with antenna
----------	--

Mechanical Drawings

Antenna

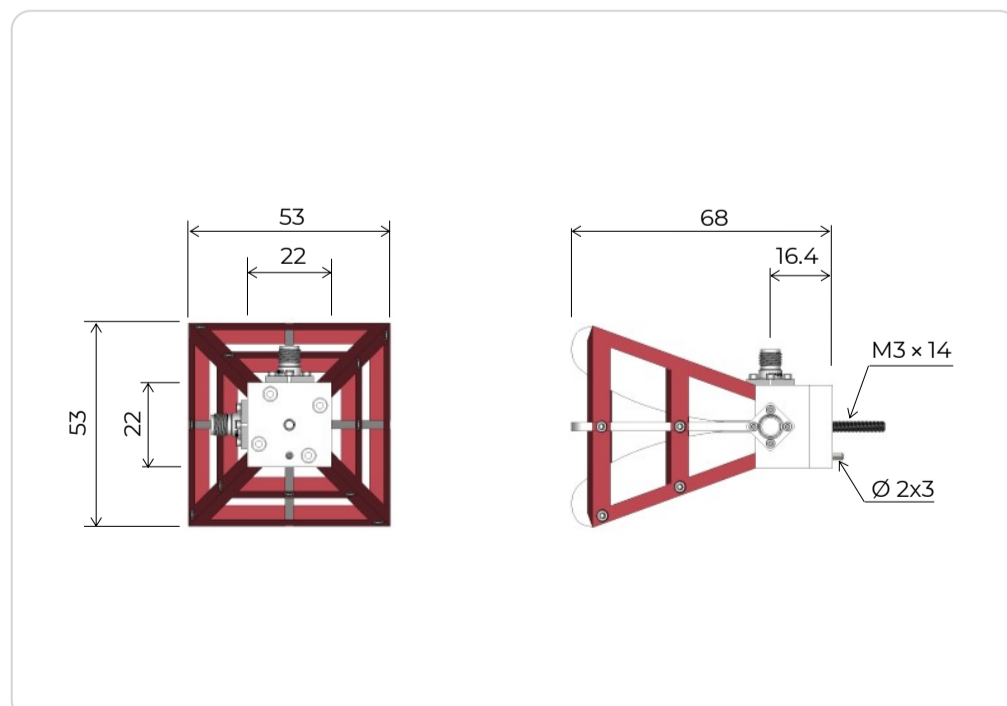

Mounting flange

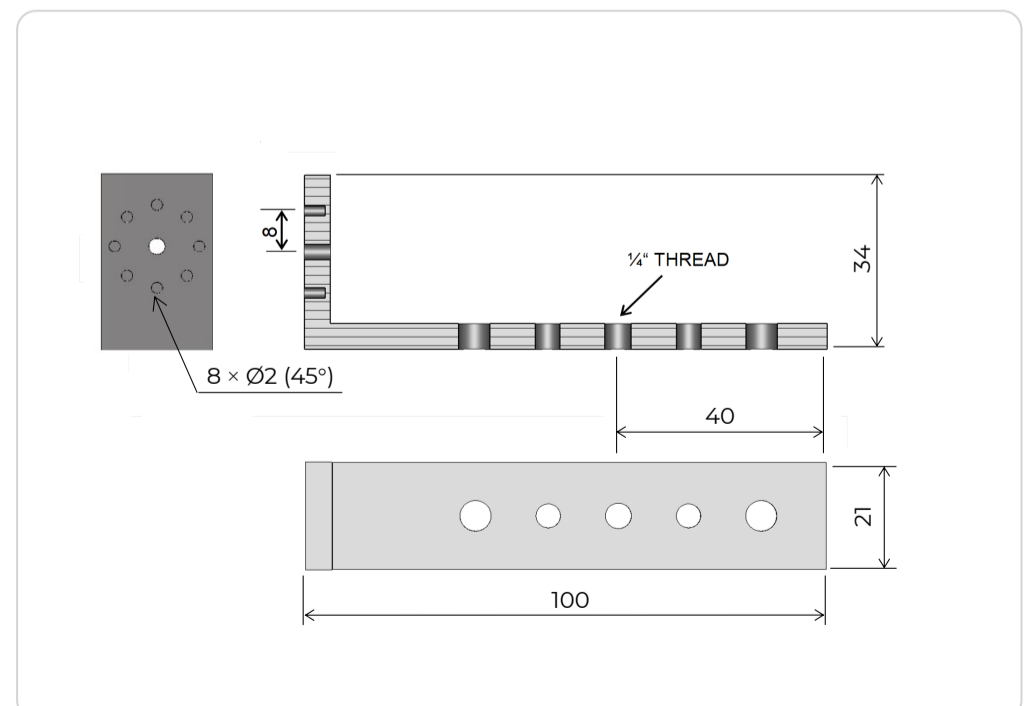

Parameters and Performance

Typical parameters

VSWR

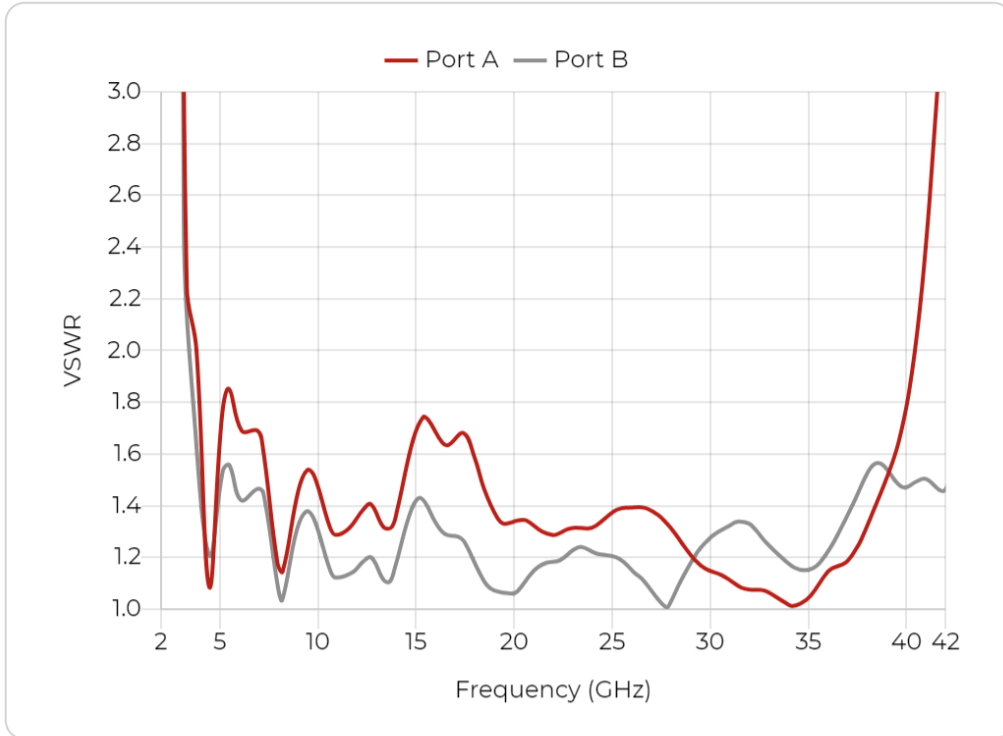

Gain

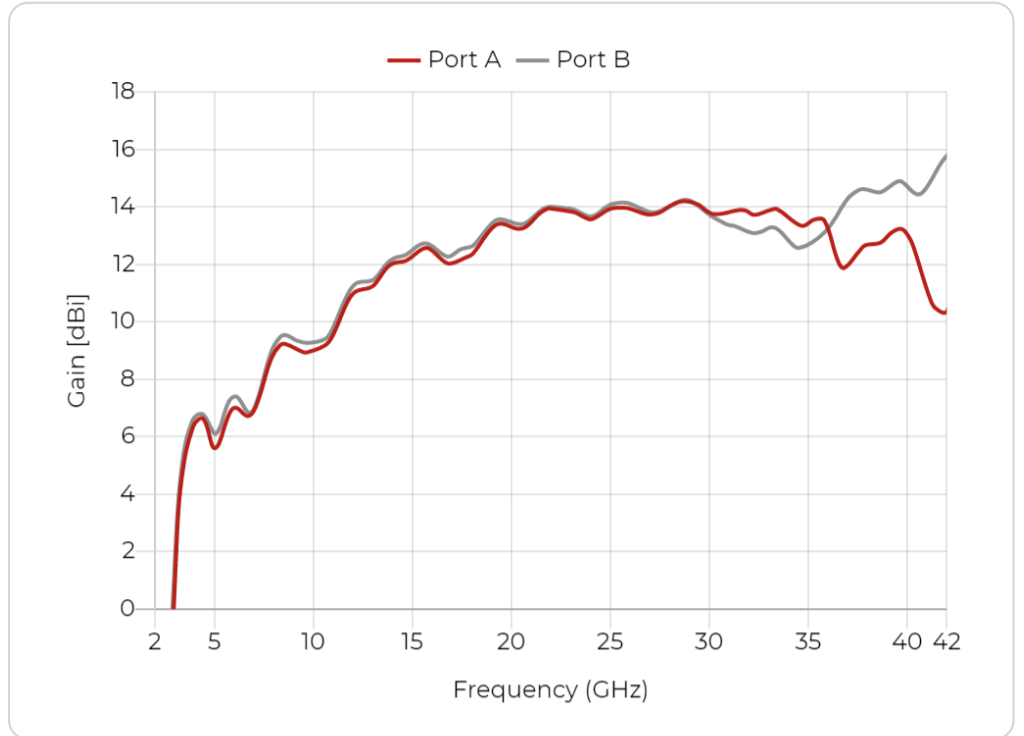

Antenna Factor

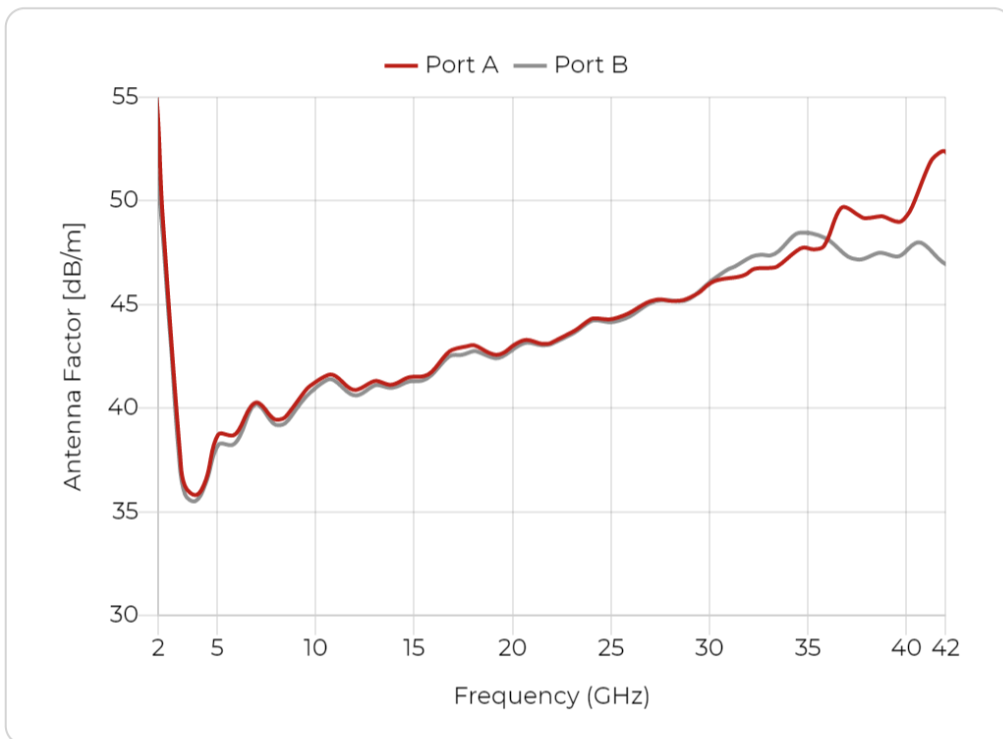

Port Isolation

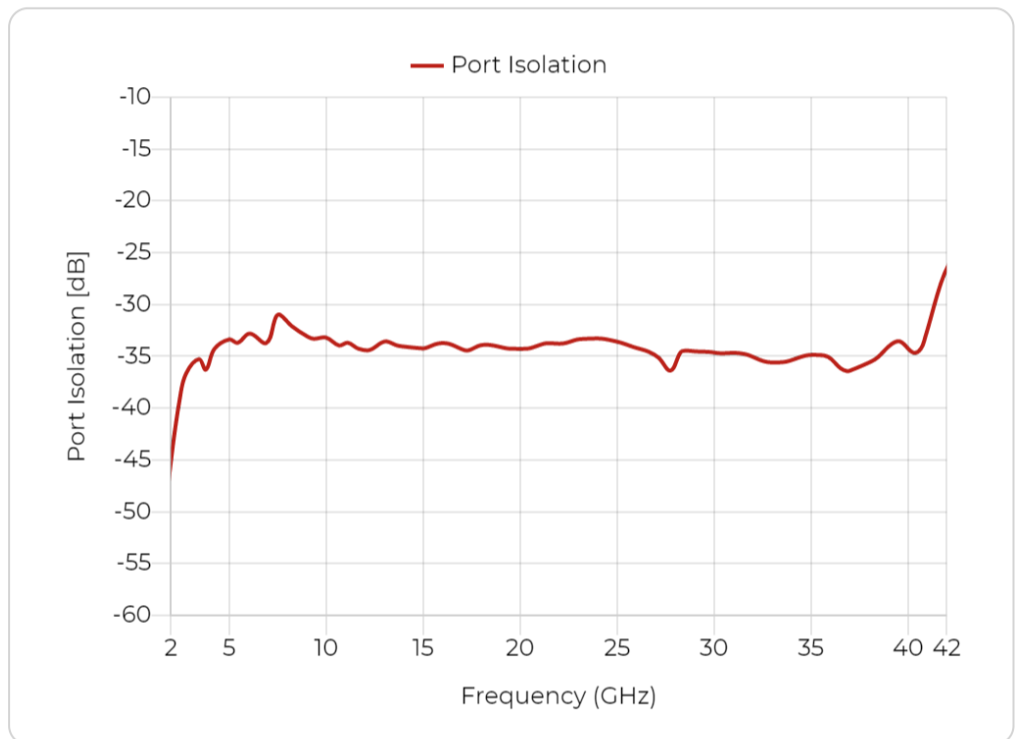

Cross Polarization

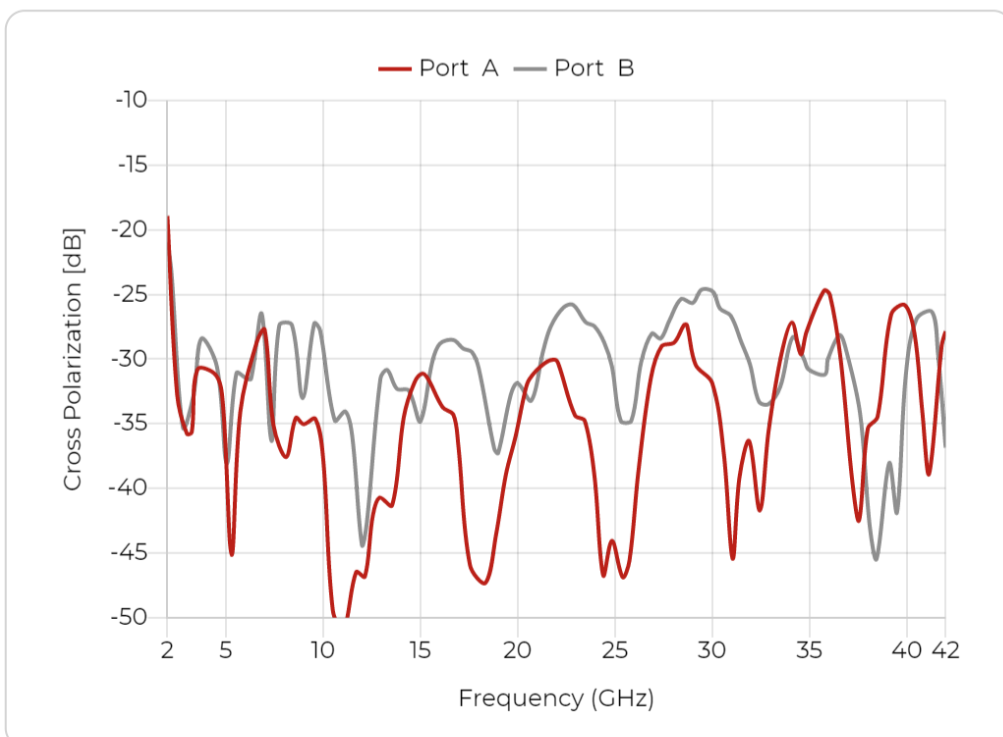

Beamwidth

Port A, E plane

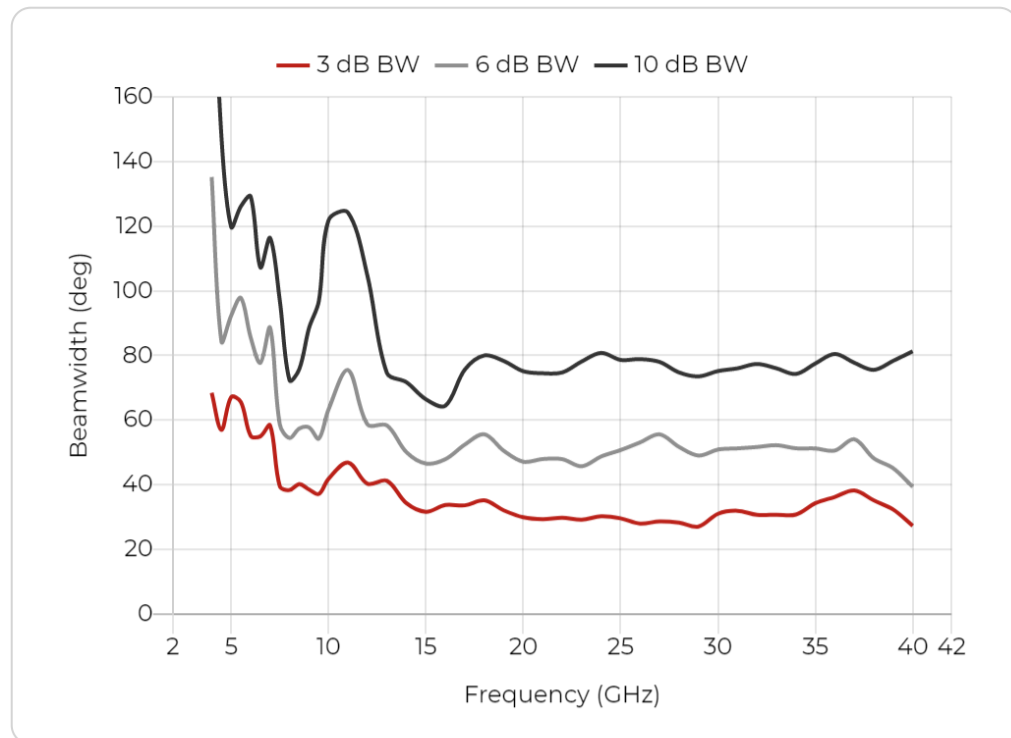

Port A, H plane

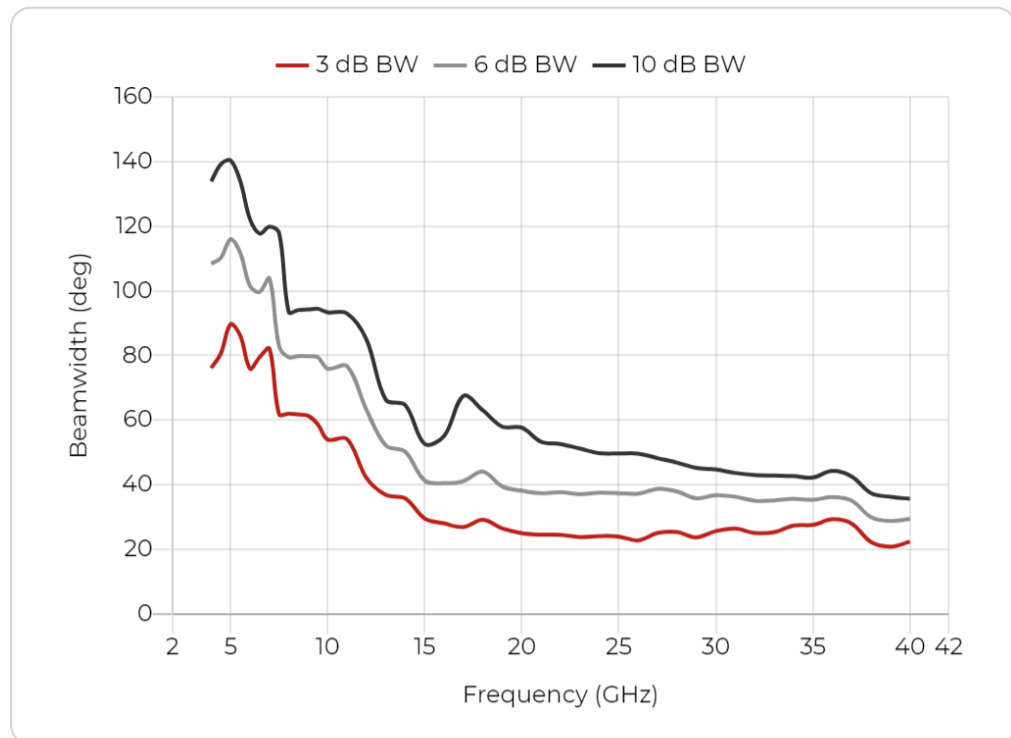

Port B, E plane

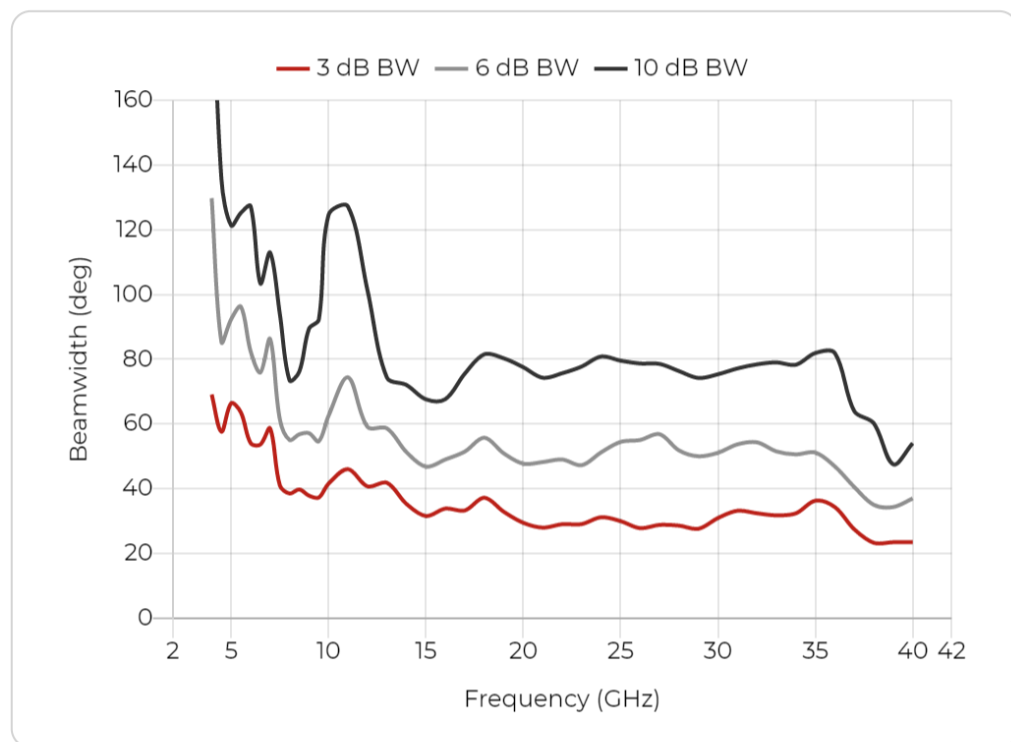

Port B, H plane

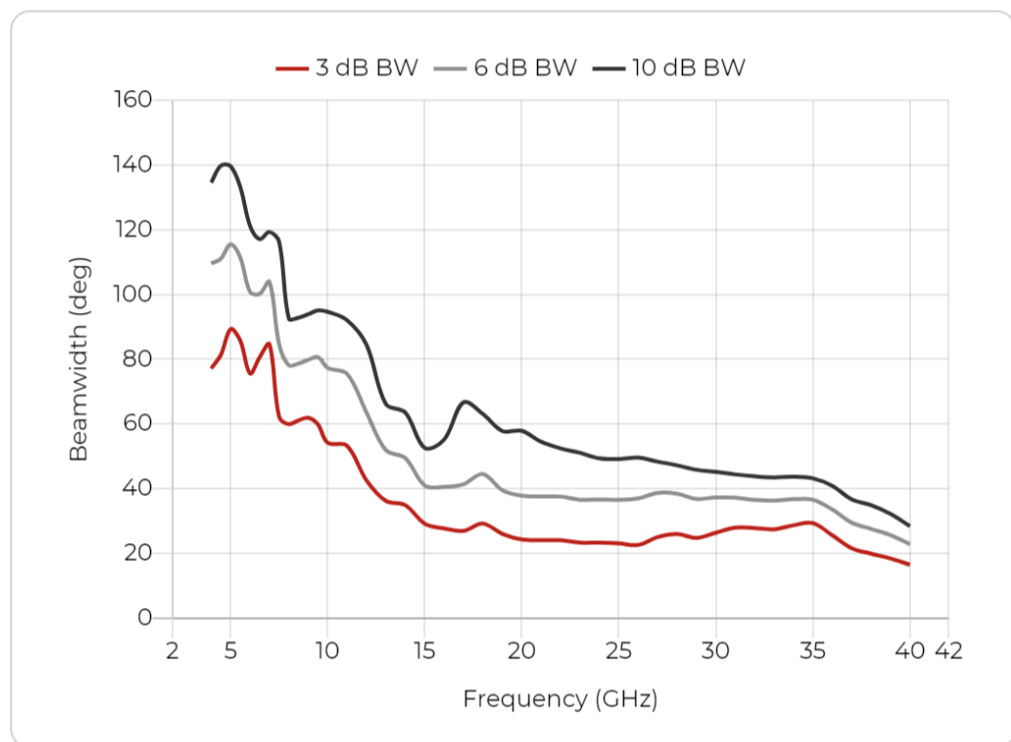

Radiation Patterns - Port A

Port A, 4 GHz

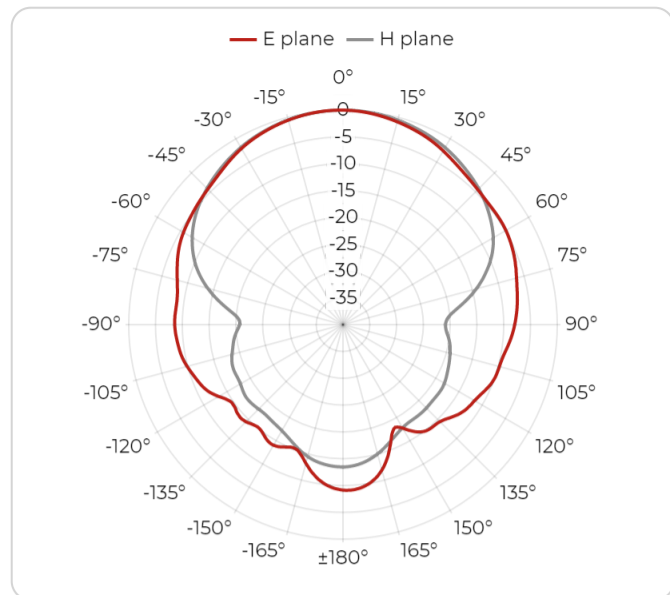

Port A, 6 GHz

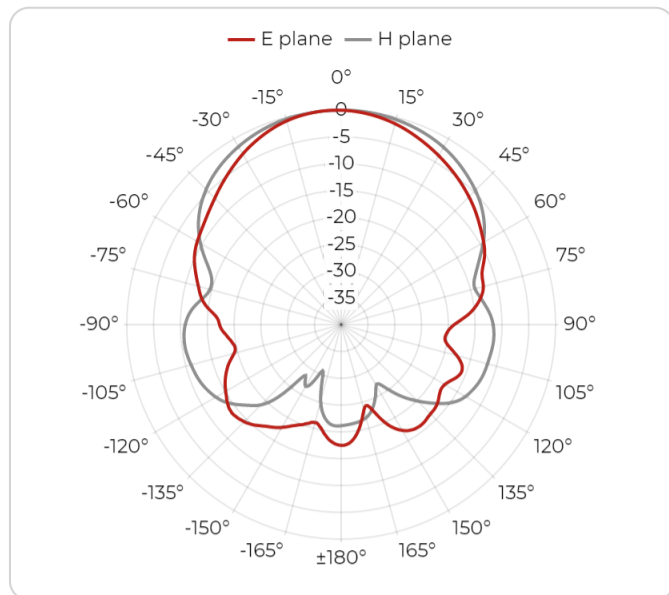

Port A, 8 GHz

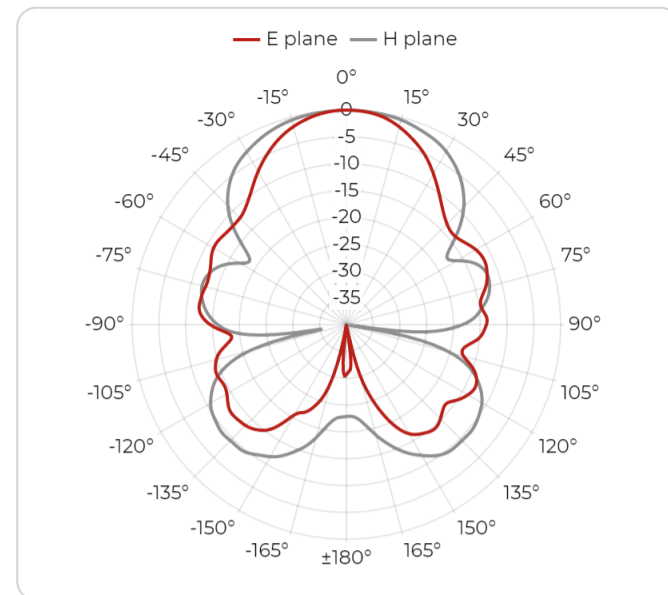

Port A, 10 GHz

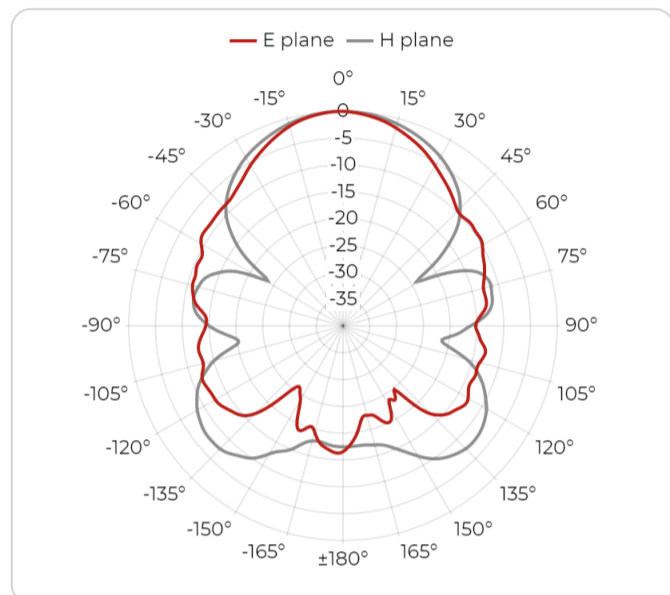

Port A, 12 GHz

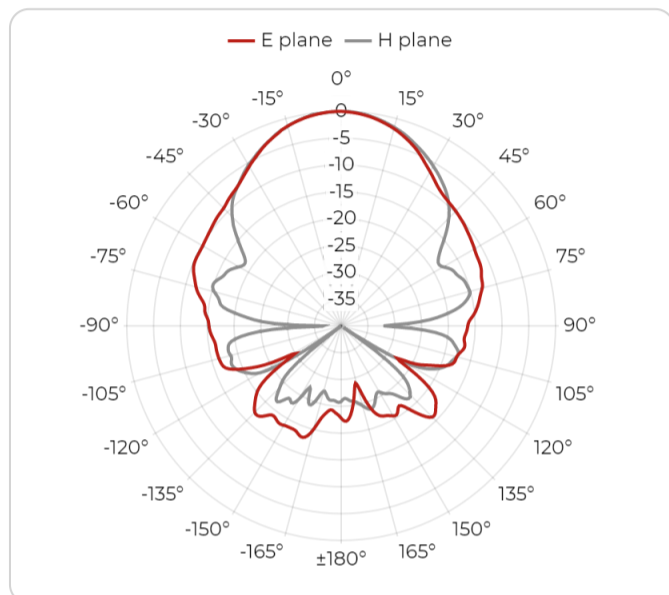

Port A, 16 GHz

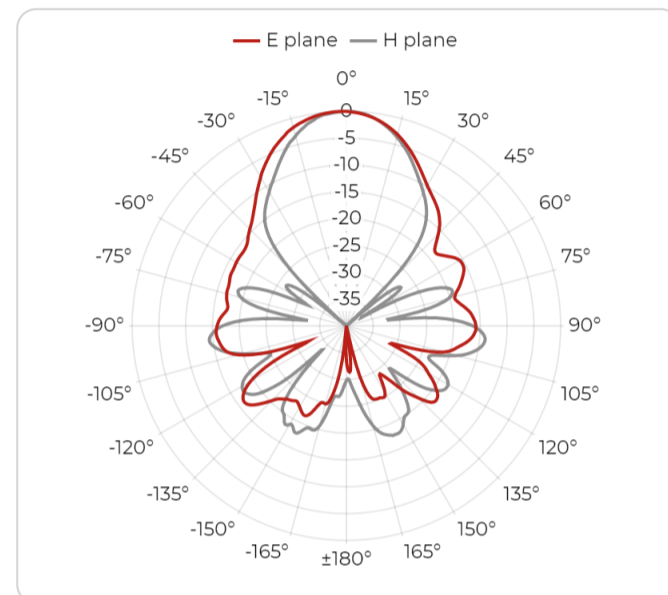

Port A, 20 GHz

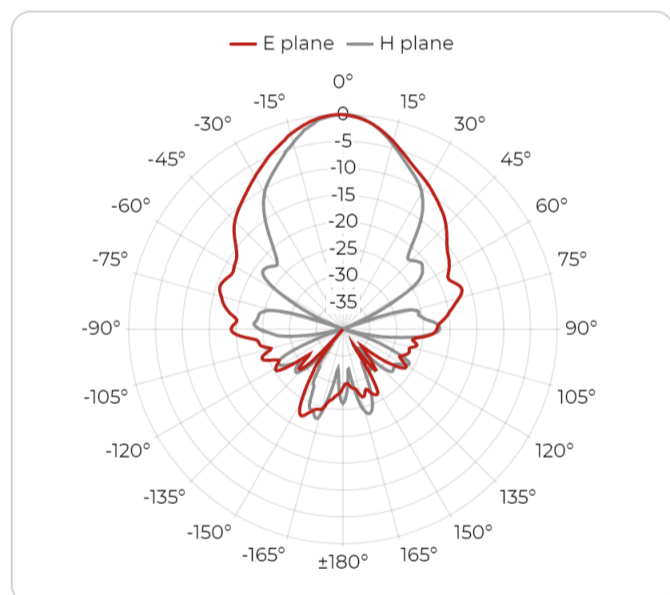

Port A, 24 GHz

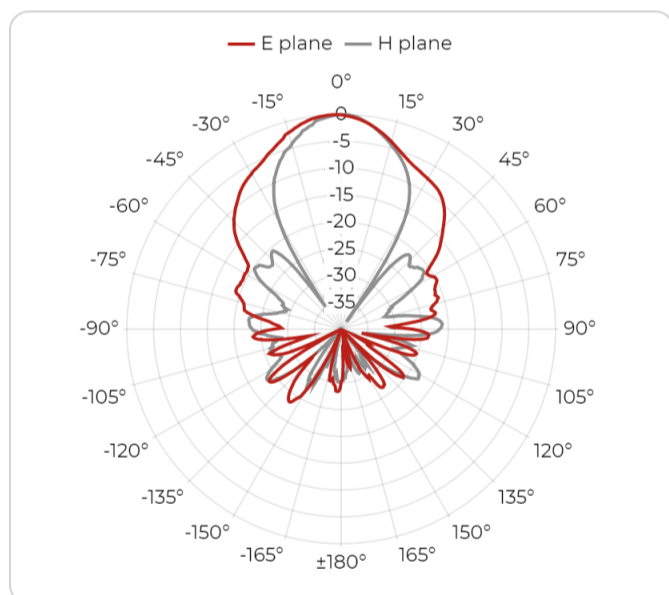

Port A, 28 GHz

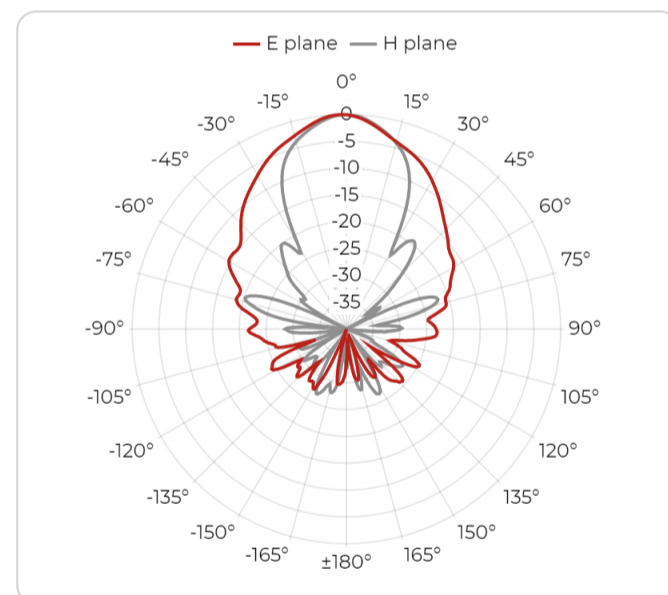

Port A, 32 GHz

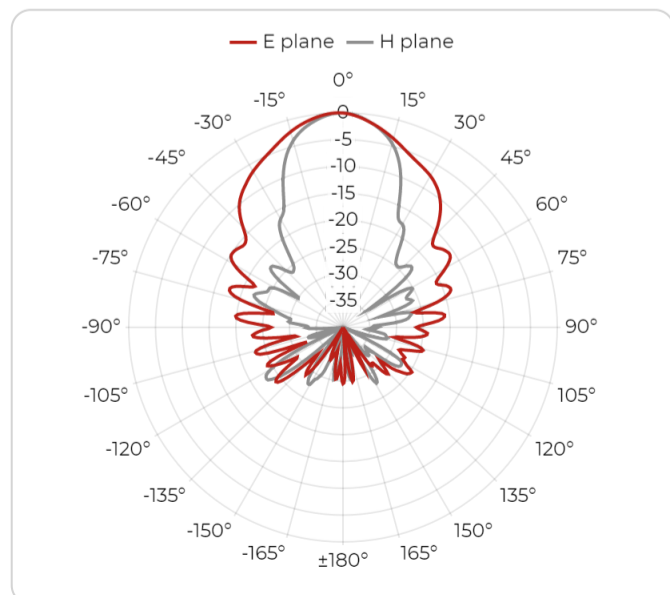

Port A, 36 GHz

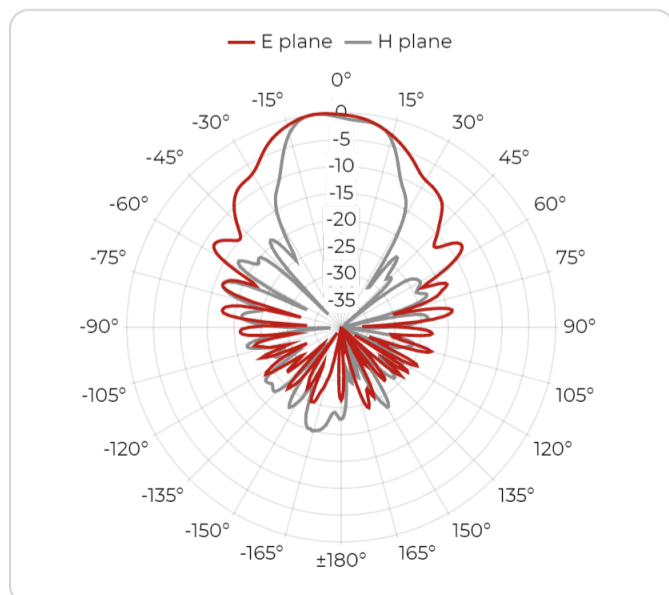

Port A, 40 GHz

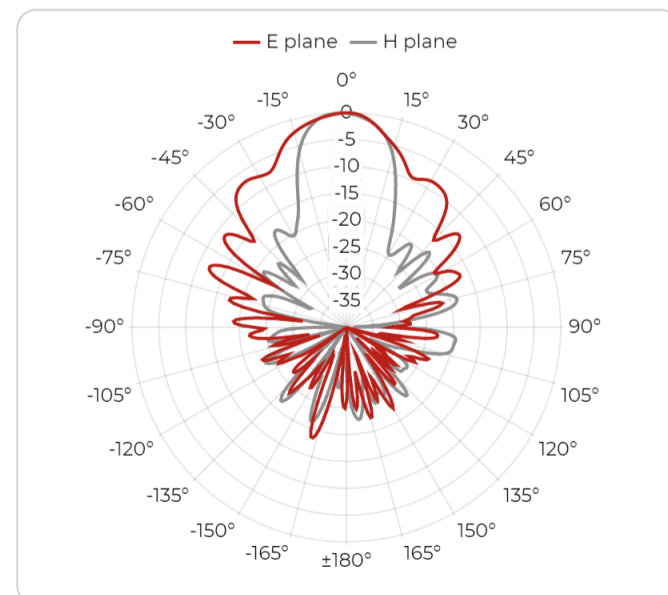

Radiation Patterns - Port B

Port B, 4 GHz

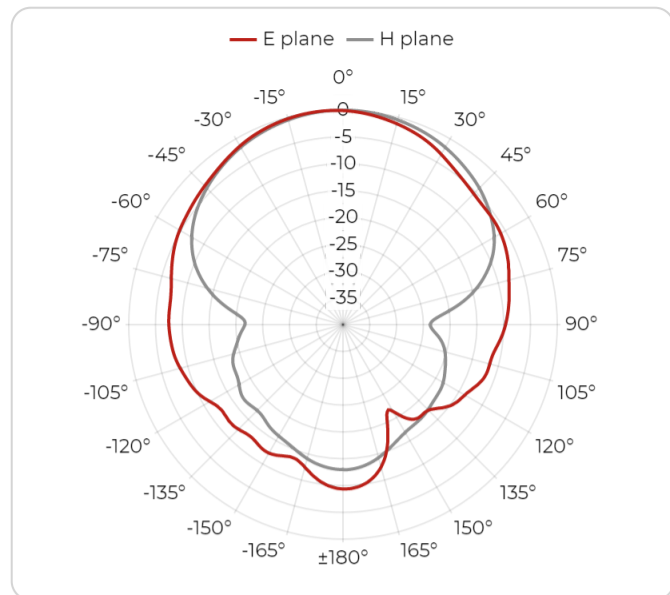

Port B, 6 GHz

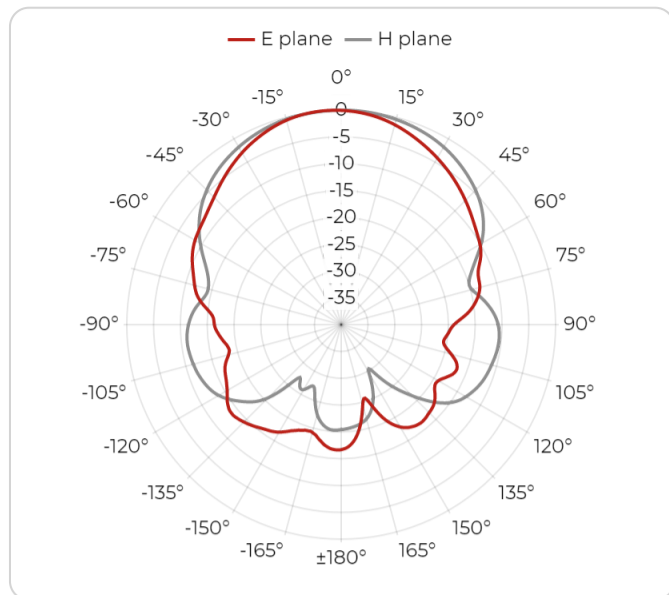

Port B, 8 GHz

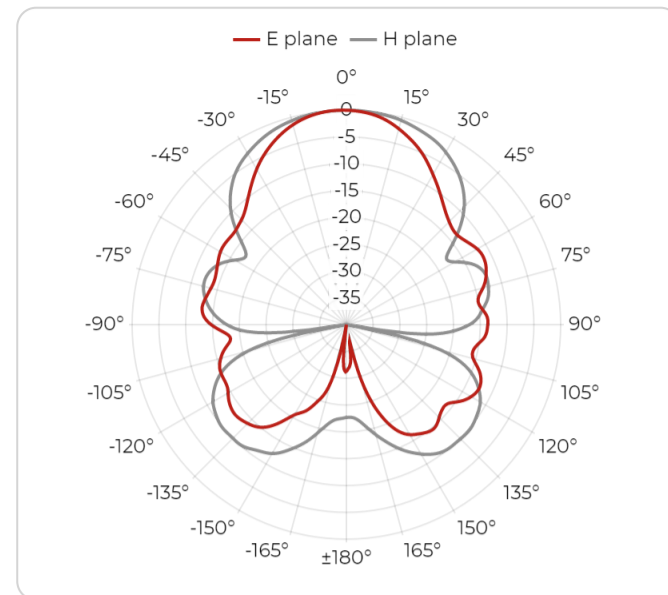

Port B, 10 GHz

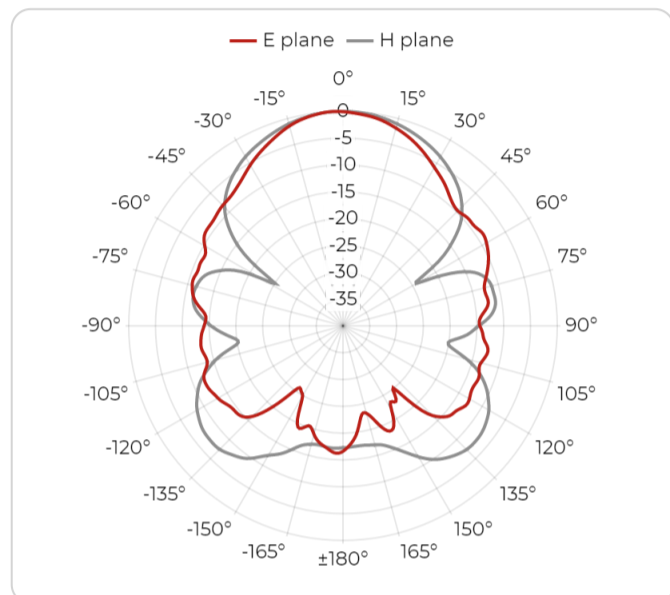

Port B, 12 GHz

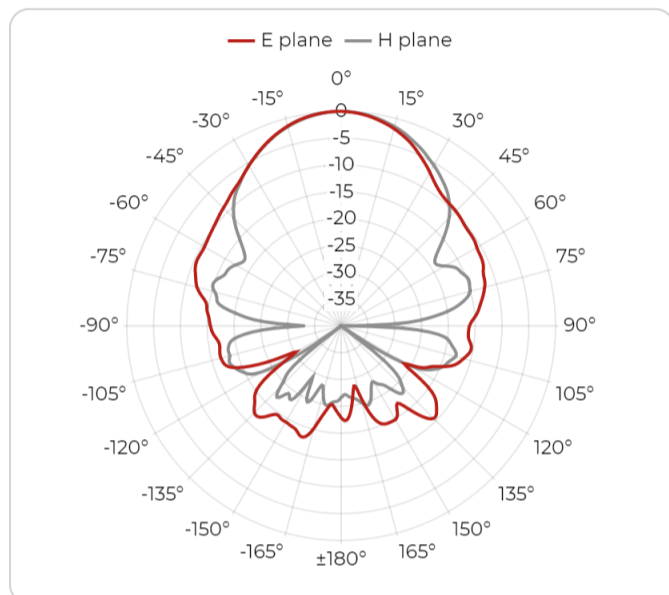

Port B, 16 GHz

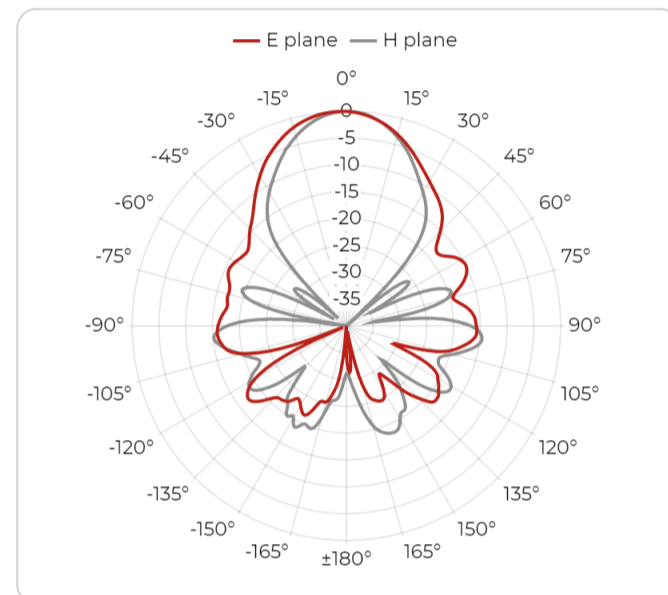

Port B, 20 GHz

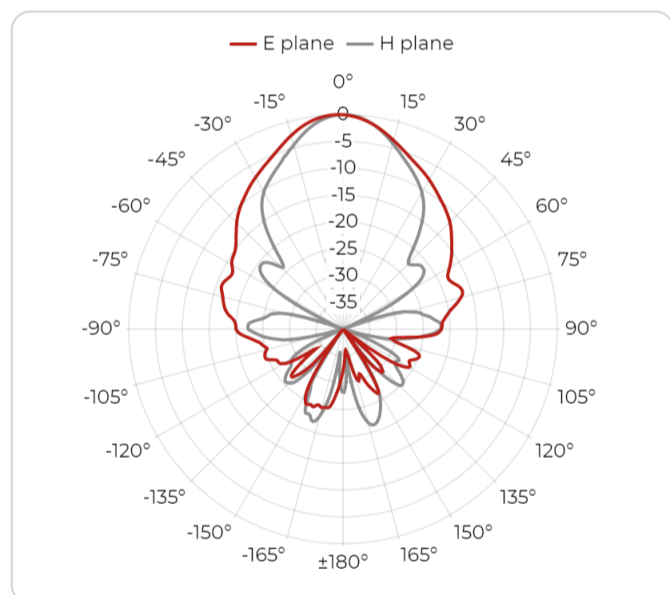

Port B, 24 GHz

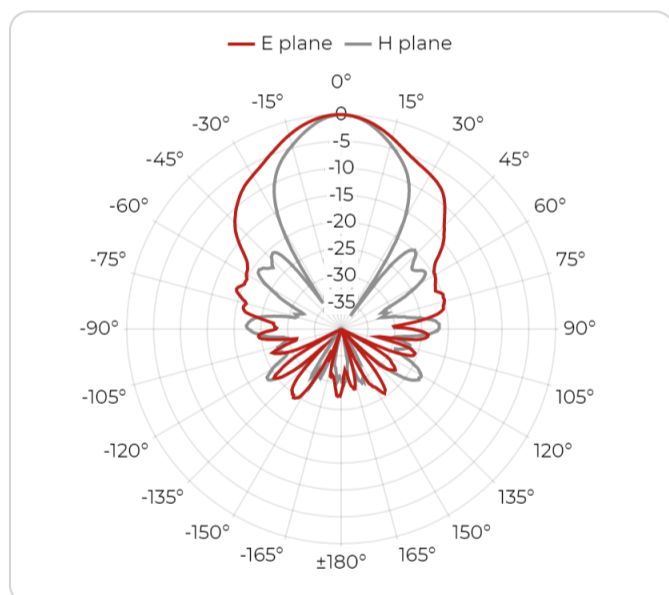

Port B, 28 GHz

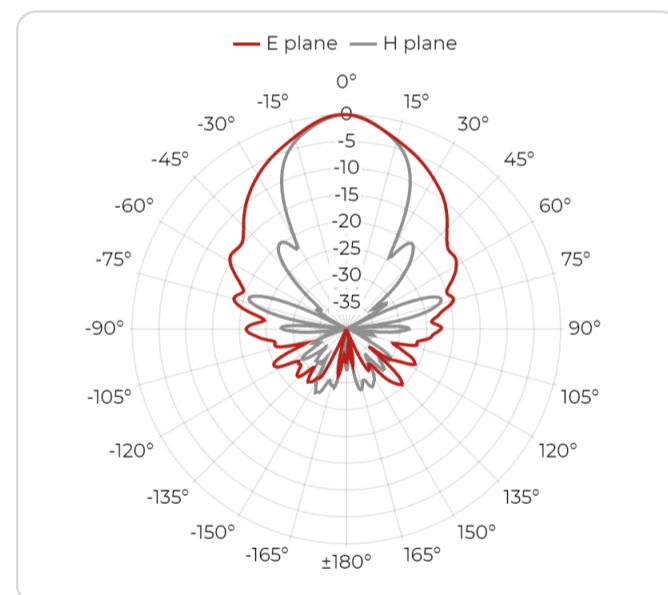

Port B, 32 GHz

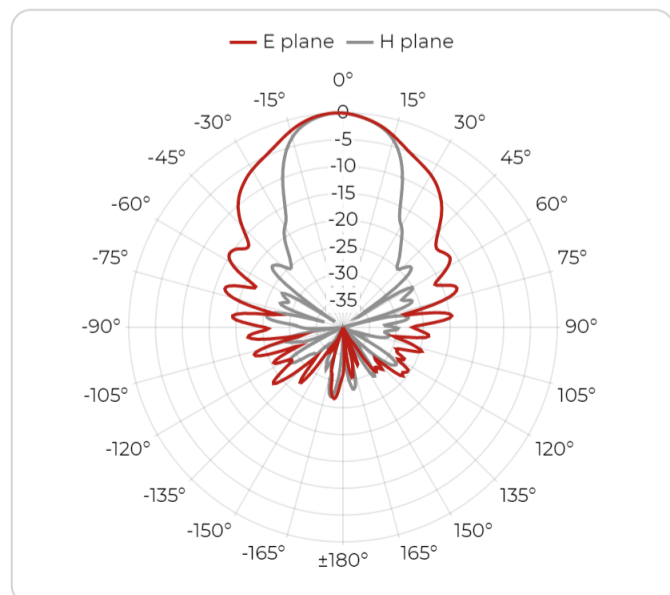

Port B, 36 GHz

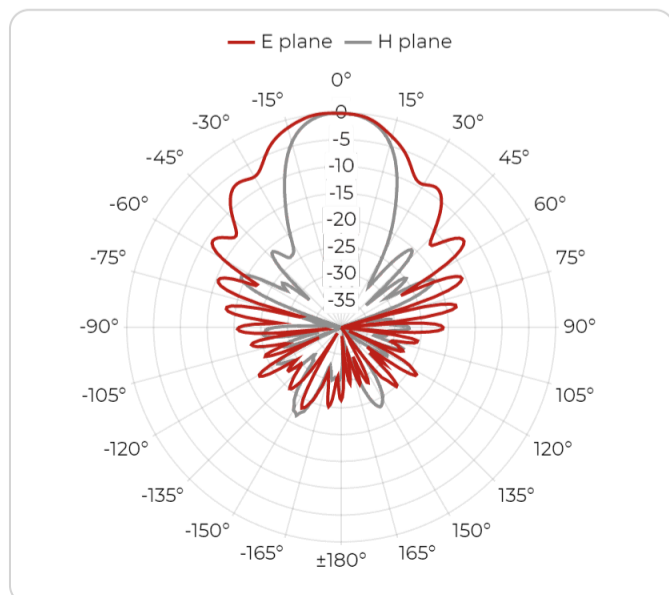

Port B, 40 GHz

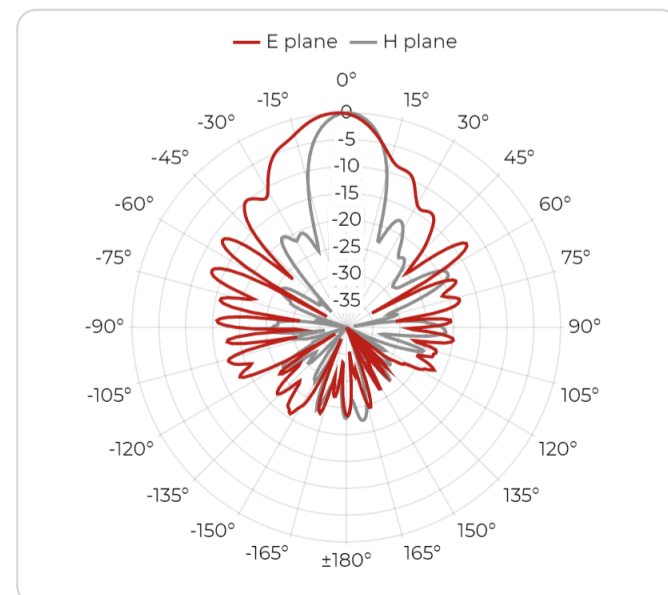

Packaging and Accessories

What's in a box

- QRH40 Antenna
- Antenna specific mount adapter with ¼ inch inner thread
- Protective wooden case
- Factory calibration certificate
- Full calibration report of each antenna
- QR code accessing online portal
- Calibration test dataset (available online)

Accessories

- Standard mounting flange

Custom services

- Custom mounting solutions
- Custom calibration data

Manufacturer Information

About Datasheet

Product information available also online at
<https://www.rfspin.com/product/grh40/>

Data and specifications subject to change without notice.

Datasheet revision 02-2024.

© RFspin 2024

📍 Address

RFspin s.r.o.
Na Beránce 57/2
160 00 Prague 6
Czech Republic

✉ E-mail

info@rfspin.com

📞 Phone

[+420 245 008 847](tel:+420245008847)